

*Tomkin*TM

A U S T R A L I A

Tomkin

Servingware/Barware 2004/5



Servingware/Barware

2004/5



Tomkin™

A U S T R A L I A

Dear Customers,

Welcome to our barware and servingware catalogue for 2004/2005.

We have reached our fourth catalogue in our series of five and trust that you will find this one helpful and informative in the area of buffet, serving and barware.

We are proud to be able to offer you such brands as Spring, Hyperlux, Ghidini, Kin Hip and other brands as well as our own range of bar and servingware. Most of you will already be familiar with our Chafer range but were you aware that we currently carry over 30 different kinds of Chafers and servers. Look out for the new induction range which I am sure will be of great interest for everyone in the catering trade.

Again we hope you find this catalogue useful and we look forward to a happy and profitable relationship together.

Your sincerely,



Andrew P Reiner



HYPERLUX[®]
18/10 Stainless Steel

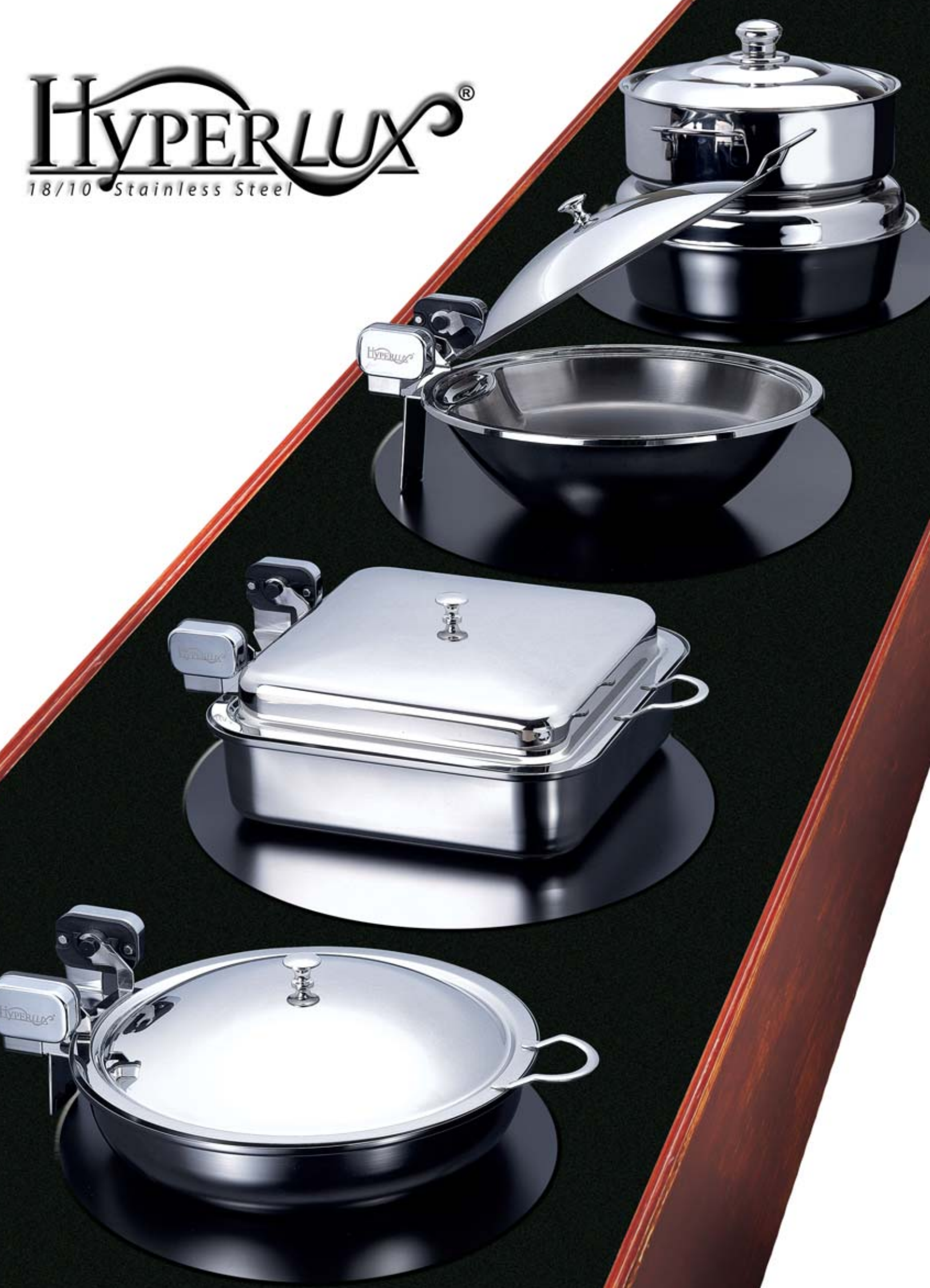

Induction Servers 18/10

The Hyperlux Pro Induction Servers are designed for state of the art food service. Made from the finest quality 18/10 stainless steel with a high mirror polish, these servers are sturdily built to withstand high intensive usage. The lids are preset to stay open at 50° and 90° and these positions are maintained due to the finely engineered clutch mechanism. A sophisticated water channelling system returns condensation to the base.

| DESCRIPTION | ITEM NO |
|----------------|------------|
| Wok Server | H-641X |
| Diameter | 390mm |
| Height | 200mm |
| Width | 490mm |
| Insert | H-65-644 |
| Ceramic Insert | H-65-644CE |



| DESCRIPTION | ITEM NO | ITEM NO | ITEM NO |
|----------------|------------|------------|----------|
| Round Server | H-643X | H-644X | H-654X |
| Diameter | 340mm | 400mm | 500mm |
| Height | 160mm | 185mm | 210mm |
| Width | 440mm | 500mm | 600mm |
| Insert | H-65-643 | H-65-644 | H-65-645 |
| Ceramic Insert | H-65-643CE | H-65-644CE | - |



| DESCRIPTION | ITEM NO | ITEM NO | ITEM NO |
|---------------|----------|----------|----------|
| Oblong Server | H-647 | H-648 | H-649 |
| Length | 320mm | 400mm | 550mm |
| Width | 440mm | 510mm | 500mm |
| Height | 180mm | 200mm | 200mm |
| Insert | H-65-647 | H-65-648 | H-65-649 |



| DESCRIPTION | ITEM NO | ITEM NO | ITEM NO |
|---------------|------------|------------|------------|
| Soup Server | H-621-06SS | H-621-08SS | H-621-10SS |
| Base Diameter | 340mm | 340mm | 340mm |
| Height | 280mm | 330mm | 290mm |
| Overall | 340mm | 340mm | 390mm |
| Capacity | 6Lt | 8Lt | 10Lt |



Baby Wave Chafers 18/10

The Hyperlux Pro Baby Wave Chafers are designed for contemporary food service. Made from the finest quality 18/10 stainless steel with a high mirror polish, these servers are sturdily built to withstand high intensive usage. The lids are preset to stay open at 50° and 90° and these positions are maintained due to the finely engineered clutch mechanism. A sophisticated water channelling system returns condensation to the base. Available with either Fuel Burners or Electric Heating Elements.

Lid opening set at 50° and 90°



| DESCRIPTION | ITEM NO | ITEM NO | ITEM NO |
|--------------------|------------|------------|----------|
| Round Chafing Dish | H-652X | H-653X | H-654X |
| Internal | 340mm | 400mm | 500mm |
| Height | 270mm | 300mm | 320mm |
| Overall | 440mm | 500mm | 600mm |
| Insert | H-65-643 | H-65-644 | H-65-645 |
| Ceramic Insert | H-65-643CE | H-65-644CE | - |



Condensation Channelling Feature



| DESCRIPTION | ITEM NO | ITEM NO | ITEM NO |
|--------------------|----------|----------|----------|
| Round Chafing Dish | H-656X | H-657X | H-658X |
| Internal | 320mm | 400mm | 550mm |
| Height | 280mm | 310mm | 310mm |
| Overall | 440mm | 510mm | 500mm |
| Insert | H-65-647 | H-65-648 | H-65-649 |



Inserts

for Hyperlux Induction Servers and Baby Wave Chafers

| ITEM NO | LENGTH | WIDTH | DEPTH | CAPACITY | GAUGE |
|------------------------------|--------|-------|-------|----------|-------|
| | (mm) | (mm) | (mm) | (Lt) | (mm) |
| Insert For Oblong Server | | | | | |
| H-65-647 suits H-647 & H-656 | 320 | 440 | 70 | 3.8 | 1.0 |
| H-65-648 suits H-648 & H-657 | 400 | 510 | 70 | 5.6 | 1.0 |
| H-65-649 suits H-649 & H-658 | 550 | 500 | 70 | 9.0 | 1.0 |



| ITEM NO | DIAMETER | DEPTH | CAPACITY | GAUGE |
|-------------------------------------|----------|-------|----------|-------|
| | (mm) | (mm) | (Lt) | (mm) |
| Insert For Round Server | | | | |
| H-65-643 suits H-641, H-643 & H-652 | 330 | 60 | 2.8 | 1.0 |
| H-65-644 suits H-644 & H-653 | 400 | 60 | 3.6 | 1.0 |
| H-65-645 suits H-645 & H-654 | 500 | 60 | 9.0 | 1.0 |



| ITEM NO | DIAMETER | DEPTH | CAPACITY |
|--|----------|-------|----------|
| | (mm) | (mm) | (Lt) |
| Ceramic Insert For Round Server | | | |
| H-65-643-CE suits H-641, H-643 & H-652 | 320 | 60 | 1.8 |
| H-65-644-CE suits H-644 & H-653 | 390 | 60 | 2.6 |



| ITEM NO | DIAMETER | DEPTH | CAPACITY | GAUGE |
|---|----------|-------|----------|-------|
| | (mm) | (mm) | (Lt) | (mm) |
| 1/2 Round Insert For Round Induction Server | | | | |
| H-65-644-2 suits H-644 & H-653 | 400x200 | 60 | 0.8 | 1.0 |



| ITEM NO | DIAMETER | DEPTH | GAUGE |
|---------------|----------|-------|-------|
| | (mm) | (mm) | (mm) |
| Insert Lifter | | | |
| H-65-408B | 150 | 20 | 0.9 |



Chafers 18/10

The Hyperlux Chafer Collection is made from the finest 18/10 Stainless Steel and polished to a high mirror sheen. The lids are detachable for easy handling and cleaning and the finely engineered clutch mechanism ensures the lids stay open at 90° and 180° for serving versatility. Available with either Fuel Burners or Electric Heating Elements.



| DESCRIPTION | ITEM NO | LENGTH (mm) | WIDTH (mm) | HEIGHT (mm) | CAPACITY (Lt) |
|--|---------|----------------|---------------|----------------|------------------|
| Chafing Dish Gastronorm 1/1 with Stainless Steel Insert | H-609 | 634 | 454 | 455 | 9.5 |



| DESCRIPTION | ITEM NO | DIAMETER (mm) | INSERT (mm) | HEIGHT (mm) | CAPACITY (Lt) |
|---|---------|------------------|----------------|----------------|------------------|
| Chafing Dish Round with Stainless Steel Insert | H-601 | 432 | 330 | 410 | 4.2 |
| | H-603 | 470 | 380 | 476 | 5.7 |

Chafers 18/10

The Hyperlux Chafer Collection is made from the finest 18/10 Stainless Steel and polished to a high mirror sheen. The lids are detachable for easy handling and cleaning and the finely engineered clutch mechanism ensures the lids stay open at 90° and 180° for serving versatility. Available with either Fuel Burners or Electric Heating Elements. Features a sophisticated water channelling system which returns condensation to the base.

| DESCRIPTION | ITEM NO | LENGTH (mm) | WIDTH (mm) | HEIGHT (mm) | CAPACITY (Lt) |
|--|---------|----------------|---------------|----------------|------------------|
| Chafing Dish Gastronorm 1/1 with Stainless Steel Insert | H-639 | 634 | 454 | 455 | 9.5 |

Condensation
Channelling
Feature



| DESCRIPTION | ITEM NO | DIAMETER (mm) | INSERT (mm) | HEIGHT (mm) | CAPACITY (Lt) |
|-----------------------------|---------|------------------|----------------|----------------|------------------|
| Chafing Dish Round | H-631 | 432 | 330 | 410 | 4.2 |
| with Stainless Steel Insert | H-633 | 470 | 380 | 476 | 5.7 |

Condensation
Channelling
Feature



Soup and Sauce Stations

Finished in high mirror polish 18/10 Stainless Steel these Hyperlux Soup & Sauce Stations are a perfect compliment to any buffet. Suitable for use with either fuel burners or electric elements.



| DESCRIPTION | ITEM NO | ITEM NO | ITEM NO |
|-----------------|----------|----------|----------|
| Soup Station | H-621-06 | H-621-08 | H-621-10 |
| Frame Diameter | 306mm | 306mm | 306mm |
| Height | 404mm | 434mm | 443mm |
| Insert Diameter | 340mm | 340mm | 390mm |
| Capacity | 6Lt | 8Lt | 10Lt |



| DESCRIPTION | ITEM NO |
|---------------|---------|
| Sauce Station | H-650-P |
| Diameter | 190mm |
| Height | 270mm |
| Width | 200mm |
| Capacity | 1.5Lt |

HYPERLUX[®] Coffee Urn

by tablekraft

Finished in high mirror polish 18/10 Stainless Steel these Hyperlux Coffee Urns are a perfect compliment to any buffet. Suitable for use with either fuel burners or electric elements.



| DESCRIPTION | ITEM NO | DIAMETER | WIDTH | HEIGHT | CAPACITY |
|-------------------------|---------|----------|-------|--------|----------|
| | | (mm) | (mm) | (mm) | (Lt) |
| Coffee Urn Double Wall | H-613 | 302 | 413 | 555 | 12 |
| Content Level Indicator | H-615 | 265 | 376 | 529 | 8 |



| DESCRIPTION | ITEM NO | DIAMETER | WIDTH | HEIGHT | CAPACITY |
|-------------|---------|----------|-------|--------|----------|
| | | (mm) | (mm) | (mm) | (Lt) |
| Coffee Urn | H-617 | 240 | 347 | 498 | 12 |
| | H-619 | 195 | 302 | 429 | 6 |



| DESCRIPTION | ITEM NO | DIAMETER | WIDTH | HEIGHT | CAPACITY |
|-------------|---------|----------|-------|--------|----------|
| | | (mm) | (mm) | (mm) | (Lt) |
| Coffee Urn | H-623 | 265 | 410 | 540 | 20 |

HYPERLUX[®]
by tablekraft **Juice Dispensers**

Finished in high mirror polish 18/10 Stainless Steel these Hyperlux Dispensers come complete with top lid, ice tube insert, Stainless Steel stand and Transparent food grade PMMA container. Easily removable faucet for easy of cleaning.



| DESCRIPTION | ITEM NO | DIAMETER (mm) | WIDTH (mm) | HEIGHT (mm) | CAPACITY (Lt) |
|-----------------|---------|------------------|---------------|----------------|------------------|
| Juice Dispenser | H-611 | 199 | 300 | 633 | 7 |

| DESCRIPTION | ITEM NO | DIAMETER (mm) | WIDTH (mm) | HEIGHT (mm) | CAPACITY (Lt) |
|------------------|---------|------------------|---------------|----------------|------------------|
| Juice Dispenser | H-626 | 170 | 310 | 540 | 4 |
| with oblong base | H-625 | 199 | 348 | 605 | 7 |

Finished in high mirror polish 18/10 Stainless Steel these Hyperlux Dispensers are an ideal complement for any buffet setting.



| DESCRIPTION | ITEM NO | DIAMETER | WIDTH | HEIGHT | CAPACITY |
|-------------------------------|---------|----------|-------|--------|----------|
| | | (mm) | (mm) | (mm) | (Lt) |
| Milk Dispenser w/ Oblong Base | H-628 | 156 | 348 | 475 | 5 |
| Milk Can Only | H-629 | 150 | 175 | 260 | 5 |

| DESCRIPTION | ITEM NO | DIAMETER | WIDTH | HEIGHT | CAPACITY |
|------------------|----------|----------|-------|--------|----------|
| | | (mm) | (mm) | (mm) | (Lt) |
| Cereal Dispenser | H-630-04 | 160 | 320 | 640 | 4 |
| with Oblong Base | H-630-07 | 199 | 348 | 703 | 7 |



Rondo Renaissance Chafers 18/10

Spring Rondo Renaissance compiles with the high standards of elegant gastronomy. With their exclusive design, superior quality, impeccable workmanship and many unique functions, Spring RONDO chafing dishes meet the demands of the world's top professional gastronomy. The resistance axle allows a smooth opening and closing of the rolltop lid. The opening positions are preset at 180° (fully opened) or 120° (2/3 opened). A special channel in the lid rim conducts the condensation back from the lid into the water pan allowing no drops of water on the food or the table.



| DESCRIPTION | ITEM NO | LENGTH (mm) | WIDTH (mm) | HEIGHT (mm) | CAPACITY (Lt) |
|---|---------|----------------|---------------|----------------|------------------|
| GN 1/1 Chafer "Renaissance" Roll Top 180° Chrome Plated Feet, Handle and Resistance Cover | S2555-0 | 660 | 490 | 400 | 9.5 |

available
with
ceramic
insert



| DESCRIPTION | ITEM NO | DIAMETER (mm) | INSERT (mm) | HEIGHT (mm) | CAPACITY (Lt) |
|--|---------|------------------|----------------|----------------|------------------|
| Round Chafer "Renaissance" 300mm Stainless Steel insert Roll Top 180° Brass Feet, Handle and Resistance Cover | S2556-1 | 470 | 300 | 400 | 4 |

| DESCRIPTION | ITEM NO | DIAMETER (mm) | INSERT (mm) | HEIGHT (mm) | CAPACITY (Lt) |
|--|---------|------------------|----------------|----------------|------------------|
| Round Chafer "Renaissance" 300mm Stainless Steel insert Roll Top 180° Chrome Plated Feet, Handle and Resistance Cover | S2556-0 | 470 | 300 | 400 | 4 |



Rondo Chafers 18/10

Spring Rondo compiles with the high standards and contemporary gastronorm design. The resistance axle allows a smooth opening and closing of the rolltop lid. The opening positions are preset at 180° (fully opened) or 120° (2/3 opened). A special channel in the lid rim conducts the condensation back from the lid into the water pan allowing no drops of water on the food or the table.



| DESCRIPTION | ITEM NO | LENGTH (mm) | WIDTH (mm) | HEIGHT (mm) | CAPACITY (Lt) |
|---|---------|----------------|---------------|----------------|------------------|
| GN 1/1 Chafer Roll Top 180° Chrome Plated Handle, knob and Resistance Cover | S2509-0 | 660 | 480 | 400 | 9.5 |

| DESCRIPTION | ITEM NO | LENGTH (mm) | WIDTH (mm) | HEIGHT (mm) | CAPACITY (Lt) |
|--|---------|----------------|---------------|----------------|------------------|
| GN 1/1 Chafer Roll Top 180° Gilt Handle, Knob and Resistance Cover | S2509-2 | 660 | 480 | 400 | 9.5 |



| DESCRIPTION | ITEM NO | DIAMETER (mm) | INSERT (mm) | HEIGHT (mm) | CAPACITY (Lt) |
|---|-----------|------------------|----------------|----------------|------------------|
| Round Chafer Roll Top 180° Chrome Plated Handle and Resistance Cover | S251030-0 | 460 | 300 | 390 | 4.6 |
| | S251040-0 | 560 | 400 | 500 | 8 |

| DESCRIPTION | ITEM NO | DIAMETER (mm) | INSERT (mm) | HEIGHT (mm) | CAPACITY (Lt) |
|--|-----------|------------------|----------------|----------------|------------------|
| Round Chafer Roll Top 180° Gilt Handle and Resistance Cover | S251030-2 | 460 | 300 | 390 | 4.6 |
| | S251040-2 | 560 | 400 | 500 | 8 |

Chafers 18/10 Stainless Steel

| DESCRIPTION | ITEM NO | LENGTH (mm) | WIDTH (mm) | HEIGHT (mm) | CAPACITY (Lt) |
|---|---------|----------------|---------------|----------------|------------------|
| GN 1/1 Chafer Catering with Flat Lid No Insert Pan | S2587-0 | 640 | 350 | 340 | 9.5 |



| DESCRIPTION | ITEM NO | LENGTH (mm) | WIDTH (mm) | HEIGHT (mm) | CAPACITY (Lt) |
|--|---------|----------------|---------------|----------------|------------------|
| GN 1/1 Chafer Catering with Rolltop | S2587-6 | 640 | 380 | 390 | 9.5 |





Advantage Chafer & Coffee Urn 18/10

Spring compiles with the high standards of elegant gastronomy. It features exclusive design, outstanding quality and perfect workmanship. The opening positions are preset at 180° (fully opened) or 120° (2/3rds opened). A special channel in the lid rim conducts the condensation back from the lid into the water pan allowing no drops of water on the food or the table.

Condensation
Channelling
Feature



| DESCRIPTION | ITEM NO | DIAMETER (mm) | INSERT (mm) | HEIGHT (mm) | CAPACITY (Lt) |
|--|-----------|------------------|----------------|----------------|------------------|
| Rondo Advantage rolltop with Stainless Steel Insert | S2586-630 | 440 | 30 | 390 | 4.6 |



| DESCRIPTION | ITEM NO | DIAMETER (mm) | HEIGHT (mm) | CAPACITY (Lt) |
|---|---------|------------------|----------------|------------------|
| Coffee Urn Guilt Lid Knob and Side Handles Non Drip Tap | S2505-2 | 230 | 500 | 12 |

| DESCRIPTION | ITEM NO | DIAMETER (mm) | HEIGHT (mm) | CAPACITY (Lt) |
|--|---------|------------------|----------------|------------------|
| Coffee Urn Chrome Plates Lid Knob and 18/10 Stainless Steel Side Handles Non Drip Tap | S2505-0 | 230 | 500 | 12 |

Buffet Service - Chafers



| DESCRIPTION | ITEM NO | CAPACITY |
|--|----------------|----------|
| Electric Chafer 1/1 with 1/1 x 100mm deep insert 18/10 Stainless Steel Chafer can not be used with Handy Fuel | 54806 | 13.5Lt |
| Voltage: | 220-240V AC | |
| Power consumption: | 840-1000 Watts | |
| Water heated to: | 85°C approx. | |



Water Pan is made of high temperature Polypropylene & provides an electrically heated water jacket for the food pans



| DESCRIPTION | ITEM NO | CAPACITY |
|--|----------------|----------|
| Electric Chafer 1/1 with 1/1 x 100mm deep insert 18/10 Stainless Steel Chafer can not be used with Handy Fuel | 54805 | 13.5Lt |
| Voltage: | 220-240V AC | |
| Power consumption: | 840-1000 Watts | |
| Water heated to: | 85°C approx. | |



| DESCRIPTION | ITEM NO | CAPACITY |
|----------------------|---------|----------|
| Electric Soup Warmer | 54815 | 10Lt |
| Cover Only | 548150 | |
| Insert Only | 548151 | |
| Power Cable | 548152 | |
| Carrier Ring | 548153 | |
| Dial Knob | 548154 | |
| Thermostat | 548155 | |

| | | |
|--------------------|----------------|--|
| Voltage: | 220-240V AC | |
| Power consumption: | 840-1000 Watts | |
| Water heated to: | 85°C approx. | |



Buffet Service - Chafers

| DESCRIPTION | | ITEM NO |
|-------------------|--------------------|---------|
| Chafer Full Size | Full Size Insert | 54820 |
| with Folding Legs | Half Size Inserts | 54820-2 |
| | Third Size Inserts | 54820-3 |



| DESCRIPTION | ITEM NO |
|---|---------|
| Chafer Full Size Economy 18/10 Stainless Steel | 54800 |



| DESCRIPTION | ITEM NO |
|---|---------|
| Roll Top 180° Chafer Full Size 18/10 Stainless Steel | 54825 |



Chafer Accessories

Accessories for Chafing Dishes and Coffee Urns



DESCRIPTION Water Pan with Bolts
ITEM NO H-65-609WE



DESCRIPTION Water Pan with Bolts 330mm
ITEM NO H-65-601WE
Water Pan with Bolts 380mm
ITEM NO H-65-603WE



DESCRIPTION Coffee Urn & Soup Heating Element
ITEM NO H-65-HP080



DESCRIPTION Oblong Heating Element 700Watt
ITEM NO H-65-HP700



DESCRIPTION Oblong and Round Heating Element
ITEM NO H-65-HP190
190Watt



| DESCRIPTION | ITEM NO | DIAMETER (mm) | HEIGHT (mm) | CAPACITY (Lt) |
|----------------------|-----------|---------------|-------------|---------------|
| Food Pan Insert for | | | | |
| for 601 & 602 | H-65-601F | 330 | 65 | 3.8 |
| for 603 & 604 | H-65-603 | 380 | 65 | 5.2 |
| Water Pan Insert for | | | | |
| for 601 & 602 | H-65-601W | 330 | 100 | 6.5 |
| for 603 & 604 | H-65-603 | 380 | 100 | 8.9 |



| DESCRIPTION | ITEM NO | DIAMETER (mm) | HEIGHT (mm) | CAPACITY (Lt) |
|------------------|------------|---------------|-------------|---------------|
| 1/2 Round Insert | | | | |
| for 603 & 604 | H-65-6032F | 380 | 65 | 2.4 |

Chafer Accessories - Handy Fuel

Handy Fuel by Colgate Palmolive the hottest name in chafing fuels. Handy Fuel is available in solid and liquid formulations.

It will provide optimum flame, heat spread, with increased burn fire and constant flame temperatures.

| DESCRIPTION | ITEM NO |
|---|---------|
| Chafer Fuel 236ml (2 hours, 12 cans per carton) Ethanol | 5702 |



| DESCRIPTION | ITEM NO |
|--|---------|
| Refiller 4.5Lt Solidified, (4 cans per carton) Ethanol | 5704 |



| DESCRIPTION | ITEM NO |
|---|---------|
| "Twist Wick" (4 hours, 24 cans per carton) Diethylene | 5750 |



| DESCRIPTION | ITEM NO |
|-------------|---------|
| Fuel Holder | 54820-F |



Royale Gastronorm Dishes

Manufactured in Italy produced from the finest quality raw materials. Fired first time at 900°C for 16 hours. After glazing, fired a second time at 1300°C for 20 hours.

| DESCRIPTION | | ITEM NO | DIMENSIONS | DEPTH |
|-----------------|--------|---------|------------|-------|
| Gastronorm Dish | ¼ Size | 93211 | 530x325mm | 65mm |



| DESCRIPTION | | ITEM NO | DIMENSIONS | DEPTH |
|-----------------|--------|---------|------------|-------|
| Gastronorm Dish | ¼ Size | 93224 | 530x162mm | 65mm |



| DESCRIPTION | | ITEM NO | DIMENSIONS | DEPTH |
|-----------------|--------|---------|------------|-------|
| Gastronorm Dish | ¼ Size | 93212 | 325x265mm | 65mm |



| DESCRIPTION | | ITEM NO | DIMENSIONS | DEPTH |
|-----------------|--------|---------|------------|-------|
| Gastronorm Dish | ¼ Size | 93213 | 325x176mm | 65mm |



| DESCRIPTION | | ITEM NO | DIMENSIONS | DEPTH |
|-----------------|--------|---------|------------|-------|
| Gastronorm Dish | ¼ Size | 93223 | 354x325mm | 65mm |



| DESCRIPTION | | ITEM NO | DIMENSIONS | DEPTH |
|-----------------|--------|---------|------------|-------|
| Gastronorm Dish | ¼ Size | 93214 | 265x162mm | 65mm |



| DESCRIPTION | | ITEM NO | DIMENSIONS | DEPTH |
|-----------------|--------|---------|------------|-------|
| Gastronorm Dish | ¼ Size | 93216 | 175x162mm | 65mm |



Royale Round Inserts

Manufactured in Italy produced from the finest quality raw materials. Fired first time at 900°C for 16 hours. After glazing, fired a second time at 1300°C for 20 hours.

| DESCRIPTION | ITEM NO | DIAMETER | DEPTH |
|---------------------|---------|----------|-------|
| Round Chafer Insert | 93185 | 335mm | 65mm |
| Porcelain | 93180 | 370mm | 65mm |
| | 93181 | 430mm | 80mm |



| DESCRIPTION | ITEM NO | DIAMETER | DEPTH |
|-----------------------------------|---------|----------|-------|
| Round Chafer Insert 2 Compartment | 93186 | 335mm | 65mm |
| Porcelain | 93182 | 370mm | 65mm |
| | 93183 | 430mm | 80mm |



| DESCRIPTION | ITEM NO | DIAMETER | DEPTH |
|------------------------|---------|----------|-------|
| Round Chafer Insert | 93230 | 300mm | 45mm |
| Notched Edge Porcelain | | | |



| DESCRIPTION | ITEM NO | DIMENSIONS | DEPTH |
|-----------------------------------|---------|------------|-------|
| Round Chafer Insert 2 Compartment | 93240 | 420mm | 65mm |
| Ying Yang | | | |



Servingware - Platters



| DESCRIPTION | ITEM NO | LENGTH | WIDTH |
|------------------------------|-----------|--------|-------|
| Oval Platter 18/10 Elite | 70300-50^ | 364mm | 250mm |
| High Mirror Polish Flat Edge | 70300-51* | 411mm | 281mm |
| Gauge: 1.2mm^ 1.5mm* | 70300-52* | 460mm | 317mm |



| DESCRIPTION | ITEM NO | LENGTH | WIDTH |
|-------------------|---------|--------|-------|
| Oval Platter 18/8 | 70923 | 230mm | 150mm |
| Heavy Gauge | 70926 | 260mm | 170mm |
| Rolled Edge | 70930 | 300mm | 195mm |
| Wide Rim | 70935 | 350mm | 227mm |
| | 70941 | 410mm | 265mm |
| | 70948 | 480mm | 310mm |
| | 70956 | 560mm | 360mm |
| | 70963 | 630mm | 405mm |



| DESCRIPTION | ITEM NO | LENGTH | WIDTH |
|-------------------|---------|--------|-------|
| Oval Platter 18/8 | 70710 | 260mm | 182mm |
| Rolled Edge | 70712 | 295mm | 215mm |
| | 70714 | 350mm | 217mm |
| | 70716 | 400mm | 265mm |
| | 70718 | 450mm | 295mm |
| | 70720 | 500mm | 345mm |
| | 70722 | 550mm | 367mm |
| | 70724 | 600mm | 420mm |
| | 70726 | 650mm | 455mm |



| DESCRIPTION | ITEM NO | DIAMETER | GAUGE |
|------------------------|---------|----------|--------|
| Round Tray 18/10 Elite | 70330 | 300mm | 0.9 mm |
| High Mirror Polish | 70335 | 370mm | 1.0mm |
| | 70336 | 410mm | 1.2mm |



| DESCRIPTION | ITEM NO | DIAMETER | GAUGE |
|-------------------------|-----------|----------|-------|
| Round Tray 18/10 Giotto | MZ0256-27 | 270mm | 1.2mm |
| | MZ0256-35 | 350mm | 1.2mm |
| | MZ0256-40 | 400mm | 1.2mm |



| DESCRIPTION | ITEM NO | DIAMETER |
|-----------------|---------|----------|
| Round Tray 18/8 | 76525 | 250mm |
| Rolled Edge | 76530 | 300mm |
| | 76535 | 350mm |
| | 76540 | 400mm |

Servingware - Trays

DESCRIPTION

Serving Tray 18/10 Elite
High Mirror Polish
Flat Edge Gauge 1.5mm

ITEM NO LENGTH WIDTH

70300-07H 656mm 486mm
70300-08H 770mm 550mm



DESCRIPTION

Serving Tray 18/10 Elite
High Mirror Polish
Gauge 1.2 mm

ITEM NO LENGTH WIDTH

70300-29H 460mm 353mm
70300-31H 512mm 392mm



DESCRIPTION

Serving Tray 18/10 Novecento
High Mirror Polish
Flat Edge Gauge 1.2mm

ITEM NO LENGTH WIDTH

MZ0144-40 400mm 270mm
MZ0144-45 450mm 310mm
MZ0144-50 500mm 340mm
MZ0144-60 600mm 420mm
MZ0144-80 800mm 540mm



DESCRIPTION

Tray 18/10 Novecento
High Mirror Polish
Flat Edge
Gauge 1.2mm

ITEM NO LENGTH WIDTH

MZ0141-30 300mm 210mm
MZ0141-35 350mm 240mm
MZ0141-40 400mm 270mm
MZ0141-45 450mm 310mm
MZ0141-50 500mm 340mm
MZ0141-60 600mm 420mm
MZ0141-80 800mm 540mm



Servingware - Trays



| DESCRIPTION | ITEM NO | LENGTH | WIDTH |
|--------------------------|-----------|--------|-------|
| Serving Tray 18/10 Elite | 70300-01^ | 305mm | 253mm |
| High Mirror Polish | 70300-02^ | 385mm | 290mm |
| Flat Edge | 70300-03* | 458mm | 332mm |
| Gauge: 1.2mm^ 1.5mm* | 70300-04* | 507mm | 376mm |
| | 70300-05* | 558mm | 424mm |
| | 70300-06* | 609mm | 471mm |
| | 70300-07* | 656mm | 486mm |
| | 70300-08 | 770mm | 550mm |



| DESCRIPTION | ITEM NO | LENGTH | WIDTH |
|------------------------------|----------|--------|-------|
| Serving Tray 18/10 | 70300-10 | 325mm | 265mm |
| High Mirror Polish Flat Edge | | | |
| Gauge 1.2mm | | | |



| DESCRIPTION | ITEM NO | LENGTH | WIDTH |
|------------------------------|---------|--------|-------|
| Serving Tray 18/10 | 70326 | 384mm | 290mm |
| High Mirror Polish Flat Edge | | | |
| Gauge 1.2mm | | | |



| DESCRIPTION | ITEM NO | LENGTH | WIDTH |
|------------------------------|---------|--------|-------|
| Octagonal Serving Tray 18/10 | 70327 | 250mm | 195mm |
| High Mirror Polish | 70328 | 370mm | 271mm |
| Gauge 1.2mm | 70329 | 460mm | 353mm |



| DESCRIPTION | ITEM NO | LENGTH | WIDTH |
|--------------------|---------|----------|-------------|
| Serving Tray 18/10 | GN 1/1 | 70300-11 | 530mm 325mm |
| Gauge 1.2mm | GN 1/2 | 70300-12 | 325mm 265mm |



Servingware - Serving Accessories

| DESCRIPTION | ITEM NO | HEIGHT | WIDTH |
|--|---------|--------|-------|
| 3 Tier High Tea Stand | H-583L | 400mm | 285mm |
| 18/10 Stainless Steel Frame and Plates | H-583 | 250mm | 180mm |

HYPERLUX
by tablecraft



| DESCRIPTION | ITEM NO | DIAMETER | HEIGHT |
|----------------------------|---------|----------|--------|
| Serving Bowl 18/10 Elite | 70366 | 300mm | 66mm |
| Condiment Bowl 18/10 Elite | 70365 | 165mm | 42mm |

HYPERLUX
by tablecraft



| DESCRIPTION | ITEM NO | DIAMETER | HEIGHT | CAPACITY |
|------------------------|---------|----------|--------|----------|
| Punch Bowl 18/10 Elite | 71670 | 320mm | 186mm | 6.0Lt |
| | 71671 | 360mm | 215mm | 9.0Lt |
| | 71672 | 420mm | 248mm | 15.0Lt |

HYPERLUX
by tablecraft



Servingware - Beverage Service



| DESCRIPTION | ITEM NO | CAPACITY |
|--|---------|----------|
| Insulated Water Pitcher 18/10 with Ice Guard | 71652 | 0.6Lt |
| | 71654 | 1.0Lt |
| | 71656 | 1.4Lt |
| Insulated Beverage Server 18/10 with Cover | 71660 | 0.35Lt |
| | 71662 | 0.60Lt |
| | 71664 | 1.0Lt |
| | 71666 | 1.4Lt |



| DESCRIPTION | ITEM NO | CAPACITY |
|-------------------------|---------|----------|
| Creamer | 7254 | 0.35Lt |
| Water Jugs Cut Edge | 7255 | 0.6Lt |
| | 7256 | 1.0Lt |
| | 7257 | 1.5Lt |
| | 7258 | 2.0Lt |
| Water Jug Hollow Handle | 7265 | 0.6Lt |
| | 7266 | 1.0Lt |
| | 7267 | 1.5Lt |
| | 7268 | 2.0Lt |



| DESCRIPTION | ITEM NO | ITEM NO | HEIGHT | CAPACITY |
|--|---------|---------|--------|----------|
| Insulated Beverage Server Satin or Mirror Finish (pictured) | Mirror | Satin | | |
| | 7571 | 7565 | 185mm | 0.3Lt |
| | 7572 | 7566 | 205mm | 0.6Lt |
| | 7573 | 7567 | 235mm | 0.9Lt |
| | 7574 | 7568 | 230mm | 1.2Lt |
| | 7575 | 7569 | 260mm | 1.5Lt |



| DESCRIPTION | ITEM NO | HEIGHT | CAPACITY |
|--|---------|--------|----------|
| Jug 18/10 Stainless Steel Satin Finish | 7260 | 210mm | 1.0Lt |

Servingware - Insulated Beverage Service

| DESCRIPTION | ITEM NO | CAPACITY |
|---|---------|----------|
| "Koffee" King with Stainless Steel Base | 7499 | 2.0Lt |
| Coffee Decanter with Black Handle | 7500 | 2.0Lt |

Kinox



| DESCRIPTION | ITEM NO | ITEM NO | CAPACITY |
|-------------------------|---------|---------|----------|
| Insulated Jug Twist Top | 4431 BK | 4431W | 0.6Lt |
| "Connoisserve" | 4432 BK | 4432W | 1.2Lt |
| | 4433 BK | 4433W | 2.0Lt |

Kinox



| DESCRIPTION | ITEM NO | CAPACITY |
|-------------------------------------|---------|----------|
| Insulated Jug Push Lever White Only | 4441W | 0.6Lt |
| "Connoisserve" | 4442W | 1.0Lt |
| | 4443W | 2.0Lt |

Kinox



| DESCRIPTION | ITEM NO | CAPACITY | |
|-------------------------------|--------------|----------|-------|
| Beverage Server | Black & Gold | 4436 | 1.0Lt |
| Triple Wall Insulated | | 4437 | 2.0Lt |
| (polycarbonate inner wall | Black | 4438 | 1.0Lt |
| is odourless and stain proof) | | 4439 | 2.0Lt |

Kinox

| DESCRIPTION | ITEM NO | CAPACITY |
|--|---------|----------|
| Elli Insulated Jug Graphite Colour | 4445 | 0.6Lt |
| "Connoisserve" | 4446 | 1.5Lt |
| (Tea, Coffee, Decaf - coloured interchangeable tabs) | 4447 | 2.0Lt |

Kinox

3 coloured I.D tabs



Servingware - Tea & Coffee Service

REGAL 18/8 TEA & COFFEE SERVICE

Mirror polish with silver argon welded spouts and insulated handles.



| DESCRIPTION | ITEM NO | ITEM NO | CAPACITY |
|----------------------|---------|------------|----------|
| Tea Pot & Coffee Pot | Tea Pot | Coffee Pot | |
| | 71813 | 71913 | 0.37Lt |
| | 71817 | 71924 | 0.50Lt |
| | 71835 | 71935 | 1.0Lt |
| | 71848 | – | 1.5Lt |
| | 71870 | 71970 | 2.0Lt |



| DESCRIPTION | ITEM NO | CAPACITY |
|--------------------------|---------|----------|
| Water Jug with ice guard | 71880 | 2.5Lt |
| Creamer | 71805 | 0.15Lt |
| | 71810 | 0.37Lt |
| Sugar Bowl with Cover | 71905 | 0.15Lt |
| | 71910 | 0.37Lt |

PRINCESS 18/8 TEA & COFFEE SERVICE



| DESCRIPTION | ITEM NO | ITEM NO | CAPACITY |
|----------------------|---------|------------|----------|
| Tea Pot & Coffee Pot | Tea Pot | Coffee Pot | |
| | 7813 | 7860 | 0.3Lt |
| | 7820 | 7870 | 0.6Lt |
| | 7832 | 7882 | 1.0Lt |
| | 7835 | 7885 | 1.5Lt |
| | 7840 | 7887 | 2.0Lt |



| DESCRIPTION | ITEM NO | CAPACITY |
|----------------------------------|---------|----------|
| Water Jug with Ice Guard | 7842 | 1.5Lt |
| | 7843 | 2.0Lt |
| Water Jug with Cover & Ice Guard | 7849 | 2.0Lt |



| DESCRIPTION | ITEM NO | CAPACITY |
|------------------------------|---------|----------|
| Creamer | 7805 | 0.15Lt |
| | 7809 | 0.3Lt |
| Sugar Bowl with Hinged Cover | 7810 | 0.14Lt |
| | 7811 | 0.3Lt |

Servingware - Tea & Coffee Service

ELITE II TEA & COFFEE SERVICE – 18/10 stainless steel with high mirror polish, hollow, heat resistant handles and traditional design.

| DESCRIPTION | ITEM NO | CAPACITY |
|--------------------------------|---------|----------|
| Tea Pot with Internal Strainer | 71611 | 0.35Lt |
| | 71613 | 0.6Lt |
| | 71615 | 1.0Lt |
| | 71617 | 2.0Lt |



| DESCRIPTION | ITEM NO | CAPACITY |
|-----------------------------------|---------|----------|
| Coffee Pot with Internal Strainer | 71601 | 0.35Lt |
| | 71603 | 0.6Lt |
| | 71605 | 1.0Lt |
| | 71607 | 1.8Lt |



| DESCRIPTION | ITEM NO | CAPACITY |
|----------------------------|---------|----------|
| Sugar Bowl Open Style | 71637 | 0.23Lt |
| Sugar Bowl with Hinged Lid | 71639 | 0.23Lt |



| DESCRIPTION | ITEM NO | CAPACITY |
|-------------|---------|----------|
| Milk Jug | 71631 | 0.15Lt |
| | 71633 | 0.23Lt |
| | 71635 | 0.35Lt |



| DESCRIPTION | ITEM NO | CAPACITY |
|--------------------------|---------|----------|
| Water Jug with Ice Guard | 71620 | 0.6Lt |
| | 71622 | 1.0Lt |
| | 71624 | 1.8Lt |



Serveware - Tea & Coffee Service

7000 SERIES 18/8 TEA & COFFEE SERVICE – Cafeteria style.



| DESCRIPTION | ITEM NO | CAPACITY |
|-------------|---------|----------|
| Tea Pot | 7012 | 0.4Lt |
| | 7016 | 0.5Lt |
| | 7020 | 0.6Lt |
| | 7032 | 1.0Lt |
| | 7048 | 1.5Lt |
| | 7050 | 2.2Lt |
| | 7051 | 3.0Lt |



| DESCRIPTION | ITEM NO | CAPACITY |
|-------------|---------|----------|
| Coffee Pot | 7061 | 0.4Lt |
| | 7062 | 0.5Lt |
| | 7063 | 0.6Lt |
| | 7064 | 1.0Lt |
| | 7065 | 1.5Lt |
| | 7066 | 2.2Lt |



| DESCRIPTION | ITEM NO | CAPACITY |
|-------------|---------|----------|
| Creamer | 7001 | 0.02Lt |
| | 7003 | 0.09Lt |
| | 7005 | 0.14Lt |
| | 7006 | 0.3Lt |



| DESCRIPTION | ITEM NO | CAPACITY |
|---------------------|---------|----------|
| Creamer Bell Shaped | 7103 | 0.85Lt |
| | 7105 | 0.14Lt |
| | 7108 | 0.22Lt |



| DESCRIPTION | ITEM NO | CAPACITY |
|------------------------------|---------|----------|
| Sugar Bowl with Hinged Cover | 7009 | 0.3Lt |



| DESCRIPTION | ITEM NO | CAPACITY |
|------------------------------|---------|-----------|
| Turkish Coffee Pot 18/10 | 7358 | 170ml |
| | 7362 | 340ml |
| | 7365 | 685ml |
| Turkish Coffee Set 3pc 18/10 | 7367 | 170-685ml |

Kinox

Servingware Accessories

| DESCRIPTION | ITEM NO | CAPACITY |
|---|---------|----------|
| Gravy Boat 18/10 Milano Wire handle (a) | 7071 | 140ml |
| | 7072 | 225ml |
| Gravy & Sauce Boat 18/8 (b) | 7075 | 140ml |
| | 7078 | 285ml |
| Gravy & Sauce Boat 18/10 (c) | 77071 | 140ml |
| | 77072 | 255ml |
| | 77073 | 425ml |



| DESCRIPTION | ITEM NO | CAPACITY | DIMENSIONS |
|----------------------------|---------|----------|------------|
| Round Sundae Cup 18/10 (a) | 70316 | 170ml | 90x75mm |
| Round Sundae Dish 18/8 (b) | 7606 | 170ml | 50x100mm |
| Fluted Sundae Cup (c) | 7505 | 142ml | 40x110mm |



| DESCRIPTION | ITEM NO | LENGTH | WIDTH |
|---|---------|--------|-------|
| Serving Tray Satin Finish Flat Edge Gauge 0.7mm | 7193 | 305mm | 227mm |



| DESCRIPTION | ITEM NO | LENGTH | WIDTH |
|--------------------|---------|--------|-------|
| Display Tray 18/10 | 7195 | 290mm | 210mm |
| | 7196 | 400mm | 300mm |
| | 7197 | 580mm | 210mm |



| DESCRIPTION | ITEM NO | CAPACITY | DIMENSIONS |
|------------------|---------|----------|------------|
| Soup Tureen 18/8 | 7490 | 3.0Lt | 245mm |
| | 7491 | 4.5Lt | 285mm |



Servingware Accessories



| DESCRIPTION | ITEM NO | CAPACITY |
|--|---------|----------|
| Conical Seafood Cocktail Dish 18/8 | 7550 | 0.15Lt |
| Conical Seafood Cocktail Dish 18/8 on Stem | 7560 | 0.15Lt |



| DESCRIPTION | ITEM NO | DIMENSIONS |
|-------------------------------------|---------|------------|
| Snail Cocktail Fork Stainless Steel | 7728 | 155mm |
| Snail Tong Stainless Steel | 7731 | 170mm |

| DESCRIPTION | | ITEM NO | DIAMETER |
|-------------|----------|---------|----------|
| Snail Plate | 6 holes | 7729 | 180mm |
| | 12 holes | 7730 | 220mm |



| DESCRIPTION | ITEM NO | DIMENSIONS |
|-----------------------------|---------|------------|
| Oyster Plates 18/8 | 7561 | 200mm |
| | 7562 | 250mm |
| Sauce Cup - Stainless Steel | 7695 | 60x20mm |



| DESCRIPTION | ITEM NO | DIMENSIONS |
|--------------------------------------|---------|------------|
| Skylab Nut/Lobster Cracker | 7992 | 180mm |
| Nut/Lobster Cracker Assorted Colours | 7745-24 | 155mm |
| Nut/Lobster Cracker Stainless Steel | 7746 | 165mm |
| Nut/Lobster Cracker Chrome | 7744 | 155mm |
| Lobster Pick Stainless Steel | 7774 | 200mm |

Servingware Accessories

| DESCRIPTION | ITEM NO | DIAMETER | DEPTH |
|-------------------------------------|---------|----------|-------|
| Round Wire Basket 18/10, Thick Wire | 70353 | 240mm | 87mm |
| Round Wire Basket 18/10, Thick Wire | 70354 | 235mm | 110mm |



| DESCRIPTION | ITEM NO | DIAMETER | DEPTH |
|-------------------------|---------|----------|-------|
| Round Wire Basket 18/10 | 70355 | 175mm | 60mm |
| Round Wire Basket 18/10 | 70356 | 245mm | 80mm |



| DESCRIPTION | ITEM NO | DIAMETER | DEPTH |
|------------------------|---------|----------|-------|
| Oval Wire Basket 18/10 | 70358 | 200mm | 145mm |
| Oval Wire Basket 18/10 | 70359 | 275mm | 220mm |



| DESCRIPTION | ITEM NO | |
|--------------------------------------|---------|------|
| Toast Rack 18/10 | 4 Slice | 7634 |
| | 6 Slice | 7636 |
| Toast Rack Stainless Steel with Base | 6 Slice | 7637 |
| Egg Cup Stainless Steel | | 7338 |



| DESCRIPTION | ITEM NO | DIMENSIONS |
|---|---------|------------|
| Tea Strainer 2pc 18/10 Stainless Steel (a) | 71540 | 60x125mm |
| Tea Strainer 18/10 Stainless Steel (b) with Drip Bowl | 3190 | 140x55mm |



| DESCRIPTION | ITEM NO | DIMENSIONS | DEPTH |
|---------------------|---------|------------|-------|
| Sugar Packet Holder | 70310 | 150x75mm | 40mm |



Servingware - Bread Baskets

Polypropylene Dishwasher Safe



| DESCRIPTION | | ITEM NO | DIMENSIONS |
|--------------|-------|---------|------------|
| Bread Basket | Round | 4589 | 230mm |
| | Oval | 4599 | 230mm |



| DESCRIPTION | | ITEM NO | DIMENSIONS |
|--------------------------|--|---------|--------------|
| Bread Basket Banquet | | 4575 | 450x300x75mm |
| Bread Basket Rectangular | | 4579 | 230x165x75mm |



| DESCRIPTION | | ITEM NO | DIMENSIONS |
|---------------------|--|---------|--------------|
| Bread Tray | | 4573 | 330x215x25mm |
| Oval Cracker Basket | | 4577 | 220x90mm |



| DESCRIPTION | | ITEM NO | DIMENSIONS |
|---------------------|--|---------|--------------|
| French Bread Basket | | 4556 | 360x140mm |
| Bread Roll Tray | | 4574 | 400x280x75mm |



| DESCRIPTION | | ITEM NO | DIMENSIONS |
|---------------------------|-------|---------|------------|
| Black & Gold Bread Basket | Round | 4558 | 230mm |
| | Oval | 4559 | 230mm |

Servingware - Serving Trays

| DESCRIPTION | ITEM NO | DIMENSIONS |
|--|---------|------------|
| Plastic Serving Tray - Black, Brown, Grey, Green Red and White | 6984 | 350x250mm |
| Hardwearing and durable polypropylene, non-skid basketweave finish, injection moulded. | 6985 | 300x400mm |
| | 6986 | 450x350mm |



| DESCRIPTION | ITEM NO | DIMENSIONS |
|-------------|---------------|------------|
| Change Tray | Black 6995-BK | 180x125mm |
| | White 6995-W | 180x125mm |

| DESCRIPTION | ITEM NO | DIMENSIONS |
|----------------------------------|---------|------------|
| Rectangular Tray, Laminated Wood | 4246 | 270x200mm |
| Mahogany | 4248 | 430x330mm |
| | 4250 | 480x370mm |
| | 4255 | 550x400mm |
| | 4260 | 600x450mm |
| Non-Slip | 4280 | 450x350mm |
| | 4285 | 510x380mm |
| | 4290 | 550x400mm |



| DESCRIPTION | ITEM NO | DIMENSIONS |
|----------------------------|---------|------------|
| Round Tray, Laminated Wood | 4230 | 330mm |
| Mahogany | 4234 | 370mm |
| | 4243 | 435mm |
| Non-Slip | 4275 | 355mm |



Buffet Servingware



BUFFET SERVINGWARE – Mirror polish, stainless steel with hollow handles.

| DESCRIPTION | ITEM NO | DIMENSIONS |
|---------------|---------|------------|
| Carving Fork | 3591 | 280mm |
| Carving Knife | 3589 | 290mm |



| DESCRIPTION | ITEM NO | DIMENSIONS |
|-------------|---------|------------|
| Salad Fork | 3594 | 290mm |
| Salad Spoon | Plain | 3596 290mm |
| | Slotted | 3599 290mm |



| DESCRIPTION | ITEM NO | SIZE | CAPACITY |
|-------------|---------|-------|----------|
| Gravy Ladle | 3593 | 290mm | 75ml |
| Soup Ladle | 3592 | 330mm | 120ml |



| DESCRIPTION | ITEM NO | DIMENSIONS |
|-------------|---------|------------|
| Cake Knife | 3587 | 290mm |
| Cake Server | 3597 | 290mm |
| Pie Server | 3598 | 290mm |



| DESCRIPTION | | ITEM NO | DIMENSIONS |
|---------------|-------|----------|------------|
| Serving Tongs | Black | 43060-BK | 240mm |
| | Clear | 43060-CL | 240mm |
| | White | 43060-W | 240mm |
| | Black | 43061-BK | 300mm |
| | Clear | 43061-CL | 300mm |
| | White | 43061-W | 300mm |

Buffet Servingware - Tongs

| DESCRIPTION | ITEM NO | DIMENSIONS |
|--|---------|------------|
| Food Tongs – Heavy Duty (a) | 70203 | 260mm |
| Pastry Tongs (b) | 70205 | 210mm |
| Pastry Tongs – Flat Head (c) | 3067 | 240mm |
| Heavy Duty Cake Tongs – Heavy Duty (d) | 70201 | 185mm |



| DESCRIPTION | ITEM NO | DIMENSIONS |
|----------------------------|---------|------------|
| Salad Tongs 18/10 (a) | 3080 | 240mm |
| Heavy Duty Salad Tongs (b) | 70202 | 240mm |
| Fork & Spoon Tongs (c) | 3079 | 210mm |

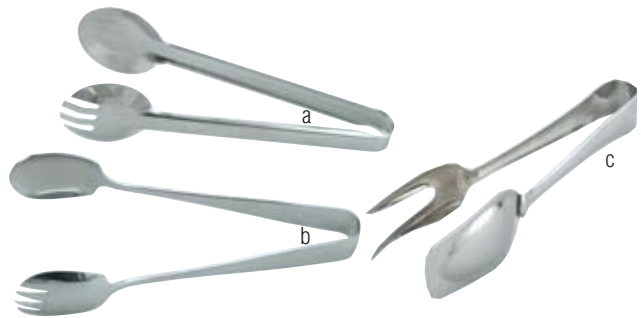

| DESCRIPTION | ITEM NO | DIMENSIONS |
|--------------------|---------|------------|
| Pastry Tongs 18/10 | 70210 | 220mm |
| Salad Tong | 70211 | 220mm |
| Pastry/Cake Tongs | 70212 | 220mm |
| Pastry/Cake Tongs | 70213 | 220mm |



| DESCRIPTION | ITEM NO | DIMENSIONS |
|----------------------|---------|------------|
| Spaghetti Tongs | 3070 | 240mm |
| Food Tongs Flat Head | 3069 | 240mm |



| DESCRIPTION | ITEM NO | DIMENSIONS |
|-------------------------|---------|------------|
| Cake Tongs Scissor Type | 3068 | 180mm |



Servingware - Pepper & Salt Mills



| DESCRIPTION | COLOUR | ITEM NO | DIMENSIONS |
|------------------|---------|---------|------------|
| Pepper/Salt Mill | Walnut | 46020 | 305x65mm |
| Ceramic Gear | Natural | 46021 | 305x65mm |



| DESCRIPTION | COLOUR | ITEM NO | DIMENSIONS |
|-------------------|----------|---------|------------|
| Pepper Mill Wood | Birch | 4483 | 300mm |
| | | 4486 | 380mm |
| | | 4489 | 450mm |
| Pepper Mills Wood | Mahogany | 4482 | 300mm |
| | | 4485 | 380mm |
| | | 4488 | 450mm |

| DESCRIPTION | COLOUR | ITEM NO | DIMENSIONS |
|--------------------------------|----------|---------|------------|
| Salt Shaker & Pepper Mill Wood | Mahogany | 4476 | 150mm |
| | Birch | 4477 | 150mm |



| DESCRIPTION | COLOUR | ITEM NO | DIMENSIONS |
|-----------------------------|--------|---------|------------|
| Salt & Pepper Mills Acrylic | Salt | 4466 | 150mm |
| | | 4467 | 200mm |
| | Pepper | 4461 | 150mm |
| | | 4462 | 200mm |

Servingware - Pepper and Salt Mills

Ceramic Gear Mills



| DESCRIPTION | ITEM NO | DIMENSIONS |
|------------------------------------|---------|------------|
| Square Pepper Mill Stainless Steel | 46032 | 160x45mm |
| Salt/Pepper Mill Beachwood | 46022 | 190x50mm |



COMBO



| DESCRIPTION | ITEM NO | DIMENSIONS |
|--|---------|------------|
| Salt/Pepper Mill Acrylic and Stainless Steel | 46030 | 175x60mm |
| Conical Salt/Pepper Mill | 46023 | 205x50mm |
| Combo Pepper Mill and Salt Shaker | 46031 | 105x40mm |



| DESCRIPTION | ITEM NO | DIMENSIONS |
|-----------------------------------|---------|------------|
| Cheese Grater Battery Operated | 46060 | 190x70mm |
| Stainless Steel | | |
| Salt/Pepper Mill Battery Operated | 46040 | 180x50mm |



Servingware - Salt & Pepper Shakers



| DESCRIPTION | ITEM NO | HEIGHT | CAPACITY |
|-----------------------------|---------|--------|----------|
| Salt & Pepper Shakers 18/10 | 7760 | 100mm | 60ml |
| | 7761 | 135mm | 90ml |
| Salt & Pepper Shakers 18/10 | 7755 | 80mm | 50ml |



| DESCRIPTION | ITEM NO | HEIGHT | CAPACITY |
|---|---------|--------|----------|
| Salt & Pepper Shakers Glass Base with Stainless Steel Top | 6650 | 70mm | 30ml |
| Salt & Pepper Shakers Glass with Stainless Steel Top | 6662 | 95mm | 60ml |
| Salt & Pepper Tower Glass Base with Chrome Plated Plastic Top | 6649 | 115mm | 115ml |



| DESCRIPTION | ITEM NO | HEIGHT | CAPACITY |
|---|---------|--------|----------|
| Salt & Pepper Shakers Glass Base with Chrome Plated Plastic Top | 6680 | 80mm | 45ml |
| Salt & Pepper Shakers Glass Base with Chrome Plated Plastic Top "City Squire" | 6679 | 80mm | 60ml |



| DESCRIPTION | ITEM NO | HEIGHT | CAPACITY |
|---|---------|--------|----------|
| Salt & Pepper Shakers Black Base with Stainless Steel Top "Egg Shape" | 7750 | 70mm | 60ml |
| Salt & Pepper Shakers Stainless Steel | | | |
| Mini Jumbo | 7766 | 60mm | 60ml |
| Jumbo | 7777 | 70mm | 170ml |

Servingware Dispensers

| DESCRIPTION | ITEM NO | HEIGHT | CAPACITY |
|--|---------|--------|----------|
| Sugar Dispenser with Chrome Plated Plastic Top "City Squire" | 6779 | 150mm | 335ml |
| "Tilt-A-Spoon" Sugar Dispenser with Stainless Steel Top | 6810 | 150mm | 285ml |



| DESCRIPTION | ITEM NO | HEIGHT | CAPACITY |
|--|---------|--------|----------|
| Sugar Dispenser with Stainless Steel Top | 6757 | 140mm | 335ml |
| "Centre Pour" Sugar Dispenser with Stainless Steel Top | 6755 | 140mm | 335ml |



| DESCRIPTION | ITEM NO | HEIGHT | CAPACITY |
|--|---------|--------|----------|
| Syrup Dispenser Glass with Chrome Plated Plastic Top | 6853 | 120mm | 280ml |
| Oil/Vinegar Bottle Glass with Stainless Steel Top | 6900 | 150mm | 180mm |



| DESCRIPTION | ITEM NO | HEIGHT | CAPACITY |
|---|---------|--------|----------|
| Glass Parmesan Cheese Shaker with Stainless Steel Top | 6800 | 140mm | 355ml |
| | 6816 | 90mm | 170ml |



| DESCRIPTION | ITEM NO | HEIGHT |
|-----------------------------------|---------|--------|
| Rack for Salt/Pepper/Sugar Packet | 6906-S | 155mm |
| Rack for Oil/Vinegar Bottle | 6905-S | 230mm |

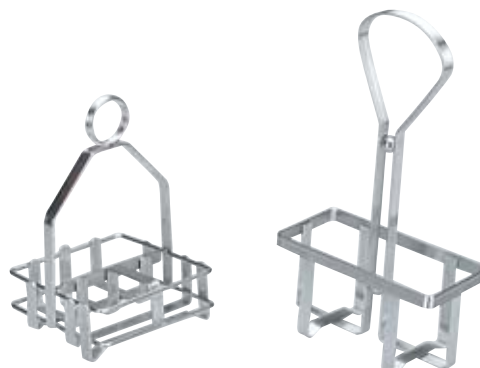

Servingware - Fastfood



| DESCRIPTION | ITEM NO | DIMENSIONS |
|----------------------|---------|---------------|
| Straw Dispenser 18/8 | 7675 | 260x150x130mm |



| DESCRIPTION | ITEM NO | DIMENSIONS | HEIGHT |
|---|---------|------------|--------|
| Napkin Dispenser Stainless Steel "D Fold" | 7282 | 130x95mm | 115mm |
| Napkin Dispenser Stainless Steel "E Fold" | 7285 | 160x100mm | 125mm |



| DESCRIPTION | ITEM NO | CAPACITY |
|---|---------|----------|
| Salt and Flour Dredge Stainless Steel with Handle | 7242 | 285ml |
| Salt and Flour Dredge Stainless Steel | 7241 | 285ml |
| | 7243 | 450ml |
| Shaker Mesh Top 18/10 | 7250 | 0.25Lt |
| | 7251 | 0.35Lt |
| | 7252 | 0.50Lt |



| DESCRIPTION | ITEM NO | CAPACITY |
|------------------------|---------|----------|
| Multi Shaker (a) | 7246 | 285ml |
| All purpose Shaker (b) | 7244 | 450ml |



| DESCRIPTION | ITEM NO | DIMENSIONS | |
|-------------------------------|---------|------------|-------|
| Squeeze Bottle | 6840 | 0.25Lt | |
| Heavy Duty Polyethylene Clear | 6845 | 0.5Lt | |
| | 6850 | 1.0Lt | |
| Squeeze Bottle | Red | 6942 | 340ml |
| Heavy Duty Polyethylene | Yellow | 6952 | 340ml |
| | Clear | 6962 | 340ml |

Serveware - Icecream Utensils

| DESCRIPTION | ITEM NO | DIAMETER | CAPACITY |
|---|---------------|----------|----------|
| Ice-cream Scoop Bonzer | 21506 - No.6 | 82mm | 165ml |
| This design includes patent lightweight arms with built-in spring for fatigue-free operation. | 21508 - No.8 | 74mm | 126ml |
| | 21510 - No.10 | 69mm | 103ml |
| | 21512 - No.12 | 64mm | 83ml |
| | 21514 - No.14 | 61mm | 72ml |
| | 21516 - No.16 | 58mm | 62ml |
| | 21520 - No.20 | 54mm | 50ml |
| | 21524 - No.24 | 50mm | 42ml |
| | 21530 - No.30 | 46mm | 32ml |
| | 21540 - No.40 | 42mm | 25ml |
| | 21570 - No.70 | 34mm | 14ml |
| 21599 - No.100 | 30mm | 10ml | |



| DESCRIPTION | ITEM NO | ITEM NO |
|--|---------------|----------------|
| Ice-cream Scoops All 18/8 Stainless Steel | 21110 - No.10 | 21130 - No.30 |
| | 21112 - No.12 | 21140 - No.40 |
| | 21116 - No.16 | 21160 - No.60 |
| | 21120 - No.20 | 21170 - No.70 |
| | 21124 - No.24 | 21200 - No.100 |
| Ice-cream Scoop Oval 63x43mm | 21202 | |



| DESCRIPTION | ITEM NO | ITEM NO |
|--|-----------------------|---------------|
| Icecream Dipper. Unique one piece design. Self-defrosting fluid in handle. | Regular 21212 - No.12 | 21216 - No.16 |
| | 21220 - No.20 | 21224 - No.24 |
| Teflon coated | 21412 - No.12 | 21416 - No.16 |
| | 21420 - No.20 | 21424 - No.24 |



| DESCRIPTION | ITEM NO |
|--|---------|
| Ice-cream Spade Stainless Steel Plastic Handle | 21100 |
| Gelati Spade Aluminium | 21700 |



| DESCRIPTION | ITEM NO | DIMENSIONS |
|--|---------|------------|
| Milkshake Cup Stainless Steel | 7676 | 180mm |
| Milkshake Cup Polypropylene Assorted Colours | 40676 | 170mm |



Serveware - Table Numbers & Stands



| DESCRIPTION | ITEM NO | HEIGHT |
|--------------------------|---------|--------|
| Table Number Stand 18/10 | 70345 | 460mm |
| | 70342 | 290mm |
| | 70340 | 190mm |
| | 70347 | 127mm |
| | 70346 | 60mm |



| DESCRIPTION | ITEM NO | DIMENSIONS |
|------------------------------|----------------------------|---------------|
| Table Number Stand (a) | 8130 | 300mm |
| | 8138 | 380mm |
| | 8145 | 450mm |
| Table Number Stand 18/10 (b) | 8125 | 200mm |
| | 8126 | 300mm |
| | 8127 | 450mm |
| Table Numbers | Set of 25 (1-25) | 8150 105x95mm |
| | Plastic Set of 50 (1-50) | 8155 105x95mm |
| | Plastic Set of 100 (1-100) | 8160 105x95mm |



| DESCRIPTION | ITEM NO | Nos |
|---|----------|-------|
| Table Numbers | 8360 BS0 | 1-10 |
| Numbers 1-80 = 75x55mm | 8360 BS1 | 11-20 |
| | 8360 BS2 | 21-30 |
| | 8360 BS3 | 31-40 |
| | 8360 BS4 | 41-50 |
| | 8360 BS5 | 51-60 |
| | 8360 BS6 | 61-70 |
| | 8360 BS7 | 71-80 |
| Reserve Signs Double Sided Plastic Black 150x15mm | 8600-BK | |

| DESCRIPTION | ITEM NO | DIMENSIONS |
|------------------------------|---------|------------|
| Menu Holder A4 Size | 4134 | 210x297mm |
| Menu Holder Acrylic on Stand | 4133 | 120x150mm |
| Buffet Card Holder Acrylic | 4135 | 90x60mm |
| Menu Holder Acrylic | 4129 | 140x200mm |

Serveware - Table Numbers & Signs

| DESCRIPTION | | ITEM NO |
|--------------|---------------------|---------|
| Table Number | 1-10 Gold on Black | 81001 |
| | 11-20 Gold on Black | 81002 |
| | 21-30 Gold on Black | 81003 |
| | 31-40 Gold on Black | 81004 |
| | 41-50 Gold on Black | 81005 |

| DESCRIPTION | | ITEM NO |
|-------------|----------------------|---------|
| | 1-10 White on Black | 81011 |
| | 11-20 White on Black | 81012 |
| | 21-30 White on Black | 81013 |
| | 31-40 White on Black | 81014 |
| | 41-50 White on Black | 81015 |

| DESCRIPTION | | ITEM NO |
|---------------|-----------------------------|---------|
| Reserved Sign | Gold on Black | 81012 |
| | White on Black | 81022 |
| | Silver on Black | 81023 |
| | Silver on Black Holographic | 81024 |

| DESCRIPTION | | | |
|----------------------------|-------|------------------|-------|
| Buffet Signs Gold on Black | | | |
| Hot Water | 81100 | Grapefruit Juice | 81131 |
| Tea | 81101 | Tomato Juice | 81132 |
| Coffee | 81102 | Apple Juice | 81133 |
| Milk | 81103 | Pineapple Juice | 81134 |
| Skim Milk | 81104 | Omelette | 81140 |
| Weetbix | 81105 | Poached Eggs | 81141 |
| Cornflakes | 81106 | Scrambled Eggs | 81142 |
| All Bran | 81107 | Eggs Benedict | 81143 |
| Special K | 81108 | French Toast | 81145 |
| Multi Grain | 81109 | Hash Browns | 81146 |
| Nutri Grain | 81110 | Sausages | 81147 |
| Muesli | 81111 | Bacon | 81148 |
| Toasted Muesli | 81112 | Tomatoes | 81149 |
| Natural Yogurt | 81115 | Mushrooms | 81150 |
| Pancakes | 81120 | Cream | 81155 |
| Waffles | 81121 | Soya Milk | 81156 |
| Danish Pastries | 81122 | Vegetarian | 81157 |
| Maple Syrup | 81123 | Decaf | 81158 |
| Orange Juice | 81130 | Full Cream Milk | 81159 |



Please consult our pricelist for our extensive range of table and wall signs

Barware - Wine Bucket Stands



| DESCRIPTION | ITEM NO | HEIGHT |
|-------------------------------------|---------|--------|
| Stand 18/10 suits wine bucket 70390 | 70391 | 600mm |
| Stand 18/10 suits bucket 70389 | 70392 | 600mm |



| DESCRIPTION | ITEM NO | HEIGHT |
|--|---------|--------|
| Stand 18/8 suits wine bucket 7892 and 7893 | 7891 | 520mm |



| DESCRIPTION | ITEM NO | HEIGHT |
|---|---------|--------|
| Ice Bucket Stand Chrome suits wine bucket 7892 and 7896 | 6888 | 620mm |
| Folding Stand suits wine bucket 7890 | 7889 | 740mm |



| DESCRIPTION | ITEM NO | DIAMETER |
|------------------------------------|---------|----------|
| Table Stand suits wine bucket 7892 | 6891 | 175mm |
| Table Stand suits wine cooler 4110 | 6892 | 130mm |
| Table Stand | 6893 | 130mm |

Barware - Wine Buckets

| DESCRIPTION | ITEM NO | DIAMETER | HEIGHT |
|----------------------------------|---------|----------|--------|
| Wine Bucket 18/10 2 Bottle (a) | 70390 | 240mm | 230mm |
| Wine Bucket 1 Bottle Elite 18/10 | 70389 | 190mm | 190mm |
| Wine Bucket Elite 18/10 (b) | 70385 | 190mm | 210mm |



| DESCRIPTION | ITEM NO | DIAMETER | HEIGHT |
|---|---------|----------|--------|
| Insulated Wine Cooler 18/8 1 Bottle Satin Finish | 70394 | 120mm | 200mm |
| Insulated Wine Bucket 18/8 | 70396 | 180mm | 210mm |



| DESCRIPTION | ITEM NO | BASE | TOP | HEIGHT |
|------------------|---------|-------|-------|--------|
| Wine Bucket 18/8 | 7893 | 125mm | 175mm | 210mm |
| Wine Bucket 18/8 | 7892 | 125mm | 175mm | 180mm |



| DESCRIPTION | ITEM NO | BASE | TOP | HEIGHT |
|-----------------------|---------|-------|-------|--------|
| Wine Bucket 18/8 | 7896 | 130mm | 165mm | 210mm |
| Champagne Bucket 18/8 | 7895 | 125mm | 190mm | 235mm |



| DESCRIPTION | ITEM NO | DIAMETER | HEIGHT |
|---|---------|----------|--------|
| Insulated Wine Cooler Acrylic *wine not included | 4110 | 115mm | 230mm |
| Wine/Champagne Bucket 18/8 | 7890 | 200mm | 250mm |



Barware - Cork Extractors



| DESCRIPTION | | ITEM NO |
|------------------------|---------------|---------|
| Cork Extractor | Chrome Plated | 5910 |
| Bench or Table Mounted | Brass | 5911 |
| Hardened Screw | Black Nickel | 5912 |



| DESCRIPTION | | ITEM NO |
|----------------|---------------|---------|
| Cork Extractor | Chrome Plated | 5915 |
| Wall Mounted | Brass | 5916 |
| Hardened Screw | Black Nickel | 5917 |

| DESCRIPTION | | ITEM NO |
|------------------------------|---------------|---------|
| Replacement Corkscrews suits | Male Thread | 5923 |
| all Cork Extractors pictured | Female Thread | 5921 |



| DESCRIPTION | ITEM NO |
|---|---------|
| Corkscrew "Cantiniere" (Black or White) | 7965B |
| Wing/Lever Corkscrew Heavy Duty "Skylab" (Chrome) | 7986 |
| Corkscrew "Tavernello" (available in Black & Red) | 7968B |



| DESCRIPTION | ITEM NO |
|--|-------------------------------|
| Wing/Lever Corkscrew Chrome Heavy Duty | 7915B-CH |
| Wing/Lever Corkscrew (Black, Red, Blue, White) | 7925 |
| French Type Corkscrew Chrome | 7935 |
| Ultra Cork Screw | Black 7940-BK White 7940-W |



| DESCRIPTION | ITEM NO |
|--|-------------------------------|
| Waiter's Friend Chrome | 7955 |
| Waiter's Friend Chrome "4 Uses" with Bottle Opener | 7956 |
| Waiters Friend with Foil Cutter | Black 7945-BK White 7945-W |
| Waiter's Friend (Black, Blue, Burgundy, Green, Red, Yellow, White) | 7957 |
| Waiter's Friend "4 Uses" with Bottle Top Opener | 7958-BK |



| DESCRIPTION | ITEM NO |
|--------------------------------------|---------|
| Champagne Stopper Chrome | 7966-CH |
| Expansion Stopper (assorted colours) | 7970 |
| Cork Puller "Gitano" | 7995 |





| DESCRIPTION | COLOUR | ITEM NO |
|------------------------------------|--------|----------|
| Skylab Wing Corkscrew | Black | 79230-BK |
| Rubber Coated Body | Blue | 79230-BL |
| | Grey | 79230-GY |
| Skylab Wing Corkscrew Satin Finish | | 79300 |



| DESCRIPTION | COLOUR | ITEM NO |
|------------------------------|----------|----------|
| Wing Corkscrew Rubber coated | Black | 79220-BK |
| | Blue | 79220-BL |
| | Burgundy | 79220-BU |
| | Grey | 79220-GY |
| Wing Corkscrew Satin Finish | | 79315 |



| DESCRIPTION | COLOUR | ITEM NO |
|------------------------------|----------|----------|
| Waiters Friend Rubber coated | Black | 79200-BK |
| | Blue | 79200-BL |
| | Burgundy | 79200-BU |
| | Grey | 79200-GY |



| | | |
|-----------------------------|--|-------|
| Waiters Friend Satin Finish | | 79320 |
|-----------------------------|--|-------|



| DESCRIPTION | ITEM NO |
|--------------------------------|---------|
| Champagne Stopper Satin Finish | 79310 |



| DESCRIPTION | ITEM NO |
|-------------------------------------|---------|
| Skylab Lobster Cracker Satin Finish | 79305 |

VIGNETO Collection

DESCRIPTION

Vigneto Cork Extractor with Foil Cutter and Stand

ITEM NO

79100



DESCRIPTION

Vigneto Table Corkscrew with Base

ITEM NO

79112

Vigneto Wing Corkscrew with Base

79111



DESCRIPTION

Vigneto Waiters Friend

ITEM NO

79110



DESCRIPTION

Vigneto Champagne Key and Stopper

ITEM NO

79113



Barware Accessories



| DESCRIPTION | ITEM NO | CAPACITY |
|---|---------|----------|
| Cocktail Shaker 18/10 Stainless Steel 3pc (a) | 77202 | 500ml |
| | 70203 | 700ml |

| DESCRIPTION | ITEM NO | CAPACITY |
|---|---------|----------|
| Cocktail Shaker 18/10 Stainless Steel 3pc (b) | 77061 | 350ml |
|  | 77062 | 500ml |
| | 77063 | 700ml |

| DESCRIPTION | ITEM NO | CAPACITY |
|--|---------|----------|
| Cocktail Shaker 18/8 Stainless Steel 3pc (c) | 7949 | 375ml |
| | 7951 | 750ml |

Kinox



| DESCRIPTION | | ITEM NO |
|--|--------------|---------|
| Cocktail Shaker 18/8 (a) | Base & Glass | 7950 |
| | Glass Only | 7950-G |
| | Base Only | 7950-B |
| Cocktail Shaker Acrylic 3pc with Recipes (b) | | 4147 |

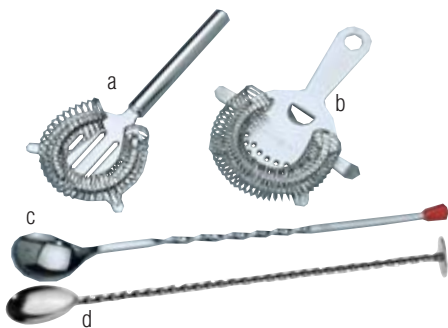

| DESCRIPTION | ITEM NO | LENGTH |
|---|---------|--------|
| Bar Strainer 18/10 (a) | 77067 | 180mm |
| Bar/Hawthorn Strainer Stainless Steel (b) | 7952 | 160mm |
| Bar/Muddling Spoon Stainless Steel (c) | 7959 | 280mm |
| Bar Spoon with Sugar Crusher (d) | 7906 | 270mm |



| DESCRIPTION | ITEM NO | DIAMETER | HEIGHT |
|-------------------------------|---------|----------|--------|
| Ice Pail 18/10 1.0Lt | 77075 | 95mm | 105mm |
| Insulated Ice Pail 18/10 with | 70397 | 130mm | 150mm |
| Lid Drainer Base & Ice Tong | | | |

HYPERLUX
Tischkraft

Barware - Dispensers & Caddies

| DESCRIPTION | ITEM NO | LENGTH | WIDTH | HEIGHT | |
|---------------------|---------|--------|-------|--------|------|
| Condiment Dispenser | 5 Comp | 7980 | 380mm | 150mm | 90mm |
| Stainless Steel | 4 Comp | 7981 | 300mm | 150mm | 90mm |
| with Hinged Cover | 6 Comp | 7982 | 450mm | 150mm | 90mm |
| Replacement Inserts | 7983 | 140mm | 75mm | 70mm | |



| DESCRIPTION | ITEM NO | LENGTH | WIDTH | HEIGHT |
|--------------------------------|---------|--------|-------|--------|
| Bar Caddy 4 Comp Polypropylene | 7977 | 480mm | 155mm | 80mm |
| Clear Cover for Bar Caddy | 7978 | | | |



| DESCRIPTION | ITEM NO | LENGTH | WIDTH | HEIGHT | |
|-----------------|-----------|--------|--------|--------|-------|
| Speed Rack | 5 bottle | 7972 | 560mm | 100mm | 153mm |
| Stainless Steel | 8 bottle | 7973 | 815mm | 100mm | 153mm |
| | 10 bottle | 7974 | 1070mm | 100mm | 153mm |

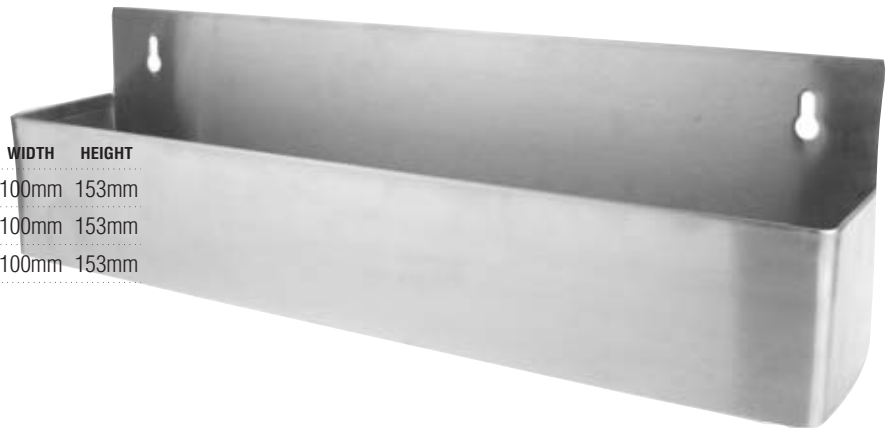

| DESCRIPTION | ITEM NO | LENGTH | WIDTH | HEIGHT |
|------------------------------------|---------|--------|-------|--------|
| Bottle Cap Catcher Stainless Steel | 7990 | 130mm | 75mm | 235mm |



| DESCRIPTION | ITEM NO |
|-------------------------|---------|
| Wall Type Bottle Opener | 7989 |



Barware - Spirit Measures



| DESCRIPTION | | ITEM NO | CAPACITY |
|-------------------|-----------------|---------|----------|
| Tru-Pour | Gold/Black | 8895-12 | 15ml |
| Spirit Dispensers | Gold/Burgundy | 8896-12 | 15ml |
| | Gold/Black | 8900-12 | 30ml |
| | Gold/Burgundy | 8901-12 | 30ml |
| | Chrome/Black | 8905-12 | 15ml |
| | Chrome/Burgundy | 8906-12 | 15ml |
| | Chrome/Black | 8910-12 | 30ml |
| | Chrome/Burgundy | 8911-12 | 30ml |
| | Black | 8915-12 | 15ml |
| | Burgundy | 8916-12 | 15ml |
| | Black | 8920-12 | 30ml |
| | Burgundy | 8921-12 | 30ml |



| DESCRIPTION | | ITEM NO | CAPACITY |
|---------------------------------------|--|---------|----------|
| Bonzer Spirit Dispensers Deluxe (a) | | 8516 | 15ml |
| | | 8531 | 30ml |
| Bonzer Spirit Dispensers Standard (b) | | 8416 | 15ml |
| | | 8431 | 30ml |



| DESCRIPTION | | ITEM NO | CAPACITY |
|----------------------------------|--------------|---------|----------|
| Bonzer Clamp Brackets Single (a) | | 8401 | 0.75/1Lt |
| | | 8402 | 2.0Lt |
| Bonzer Wall Brackets | Single | 8451 | 0.75/1Lt |
| | Single (b) | 8452 | 2Lt |
| | 4 Bottle (c) | 8454 | 0.75/1Lt |
| | 6 Bottle | 8456 | 0.75/1Lt |



| DESCRIPTION | | ITEM NO | CAPACITY |
|-------------------------|----------|---------|----------|
| Bonzer Portable Bracket | 4 Bottle | 8504 | 0.75/1Lt |
| Bonzer Rotary Stand | 4 Bottle | 8534 | 0.75/1Lt |
| | 6 Bottle | 8536 | 0.75/1Lt |



Barware - Spirit Measures

| DESCRIPTION | | ITEM NO | CAPACITY |
|---------------------------------|----------|---------|----------|
| Tru-Pour Combo Measure | Black | 8990-12 | 30ml |
| (weights and measures approved) | Burgundy | 8991-12 | 30ml |
| Tru-Pour Combo Measure | Black | 8992-12 | 15ml |
| (weights and measures approved) | Burgundy | 8993-12 | 15ml |
| Tru-Pour Free Flow | Gold | 8960-12 | |
| | Chrome | 8970-12 | |
| | Plain | 8980-12 | |



| DESCRIPTION | ITEM NO |
|--|---------|
| Speed Pours Chrome Plated (a) | 7910 |
| Speed Pours Chrome Plated with Cap (b) | 7911 |
| Speed Pours (c) | 7969 |
| Speed Pours Stainless Steel Bonzer (d) | 7900 |
| Tru-Pour Mini Free Flow Black (e) | 8999-BK |



| DESCRIPTION | ITEM NO | CAPACITY |
|---------------------------|---------|----------|
| Jigger 18/8 Bonzer | 7902 | 30ml |
| | 7903 | 60ml |
| Double Jigger 18/8 Bonzer | 7904 | 15/30ml |
| Automatic Pourer Bonzer | 7898 | 15ml |
| | 7899 | 30ml |



| DESCRIPTION | ITEM NO | LENGTH | WIDTH |
|---------------------------|---------|--------|-------|
| Bar Runner/Drainer Rubber | 7985 | 690mm | 50mm |

| DESCRIPTION | ITEM NO | CAPACITY |
|--|---------|----------|
| Jigger Acrylic (weights and measures approved) | 4400-12 | 15/30ml |
| Double Jigger 18/8 | 7905 | 15/30ml |
| Double Jigger 18/8 Tablekraft | 77065 | 15/30ml |



Barware - Glass Baskets and Hangers



| DESCRIPTION | | ITEM NO | DIMENSIONS |
|--------------|---------------|---------|------------|
| Glass Hanger | Brass Plated | 10210 | 250mm |
| | Chrome Plated | 10211 | 250mm |
| | Brass Plated | 10216 | 400mm |
| | Chrome Plated | 10217 | 400mm |
| | Brass Plated | 10224 | 600mm |
| | Chrome Plated | 10225 | 600mm |



| DESCRIPTION | | ITEM NO | DIMENSIONS |
|---------------------|--------|---------|------------|
| Glass Basket Oblong | PVC | 2800 | 430x355mm |
| | Plated | 2801 | 430x355mm |
| | Black | 2802 | 430x355mm |



| DESCRIPTION | | ITEM NO | DIMENSIONS |
|---------------------|--------|---------|------------|
| Glass Basket Square | PVC | 2810 | 355x355mm |
| | Plated | 2811 | 355x355mm |
| | Black | 2812 | 355x355mm |



| DESCRIPTION | ITEM NO |
|-------------------|---------|
| Re-Corking Device | 7914 |

Barware Accessories

| DESCRIPTION | ITEM NO |
|---------------------------|---------|
| Ice Scoop 18/8 Solid | 7920 |
| Ice Scoop 18/8 Perforated | 7924 |



| DESCRIPTION | ITEM NO | DIMENSIONS |
|----------------|---------|------------|
| Ice Tong 18/10 | 77103 | 160mm |
| Ice Tong 18/10 | 70103 | 210mm |
| Ice Tong 18/10 | 70101 | 155mm |
| | 70102 | 185mm |



| DESCRIPTION | ITEM NO | DIMENSIONS |
|---------------------------------------|---------|----------------|
| Ice Tongs Polycarbonate | Black | 43070-BK 160mm |
| | White | 43070-W 160mm |
| Ice Tong - Birds Claw Stainless Steel | 7857 | 180mm |
| Ice Tong 18/10 Stainless Steel | 7855 | 175mm |



| DESCRIPTION | ITEM NO |
|----------------------|---------|
| Citrus Squeezer 18/8 | 7962 |



UNICA WAREWASHING HANDLING SYSTEM Moulded in one piece with double wall construction from PP Co-Polymer, the Unica washracks are resistant to heat and chemicals. The base racks have comfortable handgrips on all sides for easy handling. For added height and protection use the “clip-on” extenders.



| DESCRIPTION | ITEM | DIMENSION | DEPTH |
|-------------------------|------|-----------|-------|
| 16 Compartment Cup Rack | 9516 | 500x500mm | 100mm |
| Compartment Size | | 113x113mm | 48mm |



| DESCRIPTION | ITEM | DIMENSION | DEPTH |
|-----------------------------|------|-----------|-------|
| 16 Compartment Cup Extender | 9517 | 500x500mm | 51mm |



| DESCRIPTION | ITEM | DIMENSION | DEPTH |
|-------------------------|------|-----------|-------|
| 20 Compartment Cup Rack | 9520 | 500x500mm | 100mm |
| Compartment Size | | 90x113mm | 78mm |



| DESCRIPTION | ITEM | DIMENSION | DEPTH |
|-----------------------------|------|-----------|-------|
| 20 Compartment Cup Extender | 9521 | 500x500mm | 51mm |



| DESCRIPTION | ITEM | DIMENSION | DEPTH |
|---------------------------|------|-----------|-------|
| 25 Compartment Glass Rack | 9525 | 500x500mm | 100mm |
| Compartment Size | | 89x89mm | 72mm |



| DESCRIPTION | ITEM | DIMENSION | DEPTH |
|-------------------------------|------|-----------|-------|
| 25 Compartment Glass Extender | 9526 | 500x500mm | 51mm |



| DESCRIPTION | ITEM | DIMENSION | DEPTH |
|---------------------------|------|-----------|-------|
| 36 Compartment Glass Rack | 9536 | 500x500mm | 100mm |
| Compartment Size | | 74x74mm | 71mm |



| DESCRIPTION | ITEM | DIMENSION | DEPTH |
|-------------------------------|------|-----------|-------|
| 36 Compartment Glass Extender | 9537 | 500x500mm | 51mm |

UNICA WAREWASHING HANDLING SYSTEM Moulded in one piece with double wall construction from PP Co-Polymer, the Unica washracks are resistant to heat and chemicals. The base racks have comfortable handgrips on all sides for easy handling. For added height and protection use the “clip-on” extenders.



| DESCRIPTION | ITEM | DIMENSION | DEPTH |
|---------------------------|------|-----------|-------|
| 49 Compartment Glass Rack | 9549 | 500x500mm | 100mm |
| Compartment Size | | 64x64mm | 80mm |



| DESCRIPTION | ITEM | DIMENSION | DEPTH |
|-------------------------------|------|-----------|-------|
| 49 Compartment Glass Extender | 9550 | 500x500mm | 51mm |



| DESCRIPTION | ITEM | DIMENSION | DEPTH |
|--------------------|------|-----------|-------|
| Washrack Base Open | 9555 | 500x500mm | 100mm |



| DESCRIPTION | ITEM | DIMENSION | DEPTH |
|-------------------|------|-----------|-------|
| Washrack Flatware | 9556 | 500x500mm | 51mm |



| DESCRIPTION | ITEM | DIMENSION | DEPTH |
|-------------|------|-----------|-------|
| Peg Rack | 9557 | 500x500mm | 100mm |



| DESCRIPTION | ITEM | DIMENSION | DEPTH |
|---------------------|------|-----------|-------|
| Peg Rack Open Ended | 9558 | 500x500mm | 51mm |



| DESCRIPTION | ITEM | DIMENSION | DEPTH |
|------------------------|------|-----------|-------|
| Washrack Open Extender | 9559 | 500x500mm | 51mm |



| DESCRIPTION | ITEM | DIMENSION | DEPTH |
|----------------|------|-----------|-------|
| Washrack Cover | 9550 | 505x505mm | 25mm |

Servingware - Trolleys



| DESCRIPTION | ITEM | DIMENSION |
|--------------------------------|------|-----------|
| Dolly for Washrack | 9580 | 500x500mm |
| Dolly for Washrack with Handle | 9581 | 500x500mm |



| DESCRIPTION | ITEM | LENGTH | WIDTH | HEIGHT |
|----------------|------|--------|-------|--------|
| Trolley 3 Tier | 9600 | 710mm | 420mm | 900mm |

This strong and sturdy trolley is a great helper in and out of the kitchen. It can be used to transport prepared food to the serving area and also to collect and transport dishes back to the kitchen.

ACCESSORIES AVAILABLE:

| DESCRIPTION | ITEM | LENGTH | WIDTH | HEIGHT |
|------------------|------------|--------|-------|--------|
| Flatware Basket | Grey 3641 | 530mm | 325mm | 85mm |
| Refuse Bin (a) | Black 9610 | 337mm | 231mm | 560mm |
| Flatware Bin (b) | Black 9612 | 337mm | 237mm | 187mm |
| Bus Box (c) | Grey 9614 | 370mm | 310mm | 145mm |
| Tote Box (d) | Grey 9616 | 660mm | 450mm | 230mm |



Servingware - Trolleys & Stands



| DESCRIPTION | | ITEM NO | DIMENSIONS |
|---------------|---------|---------|---------------|
| Trolley 18/10 | 2 Shelf | M-0800 | 740x480x800mm |
| | 3 Shelf | M-0801 | 850x520x800mm |

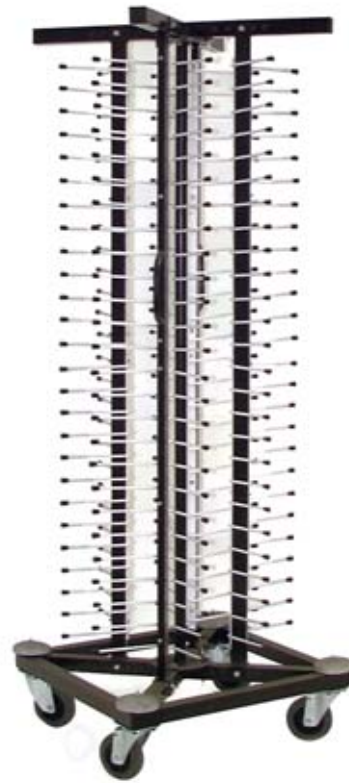

| DESCRIPTION | ITEM NO |
|---|---------|
| Trolley Plate Stacking Holds up to 100 Plates | M-0811 |



| DESCRIPTION | | ITEM NO | DIMENSIONS |
|---|--------|---------|---------------|
| Tray Stand (folds for easy handling, sturdy and durable for all food service) | Chrome | 4501-C | Open Position |
| | Black | 4501-BK | Top 480x400mm |
| | | | Height 770mm |



| DESCRIPTION | ITEM NO | DIMENSIONS |
|--------------------|--------------------------|---------------|
| Luggage Rack | Chrome 4507-C | |
| Plastic Glides | Black 4507-BK | Top 620x460mm |
| Extended Rear Legs | Open Position Platform | Height 430mm |
| | Open Position Backrest | Height 680mm |
| | Closed Position Backrest | Height 870mm |

Servingware Accessories

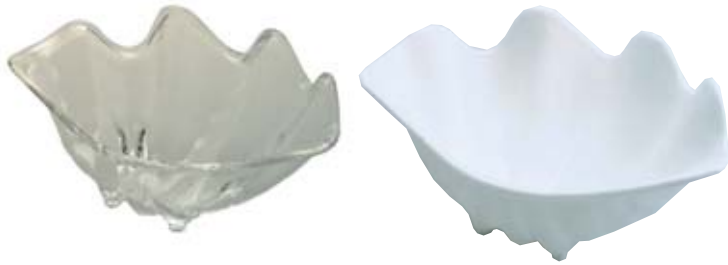

| DESCRIPTION | | ITEM NO | DIMENSIONS |
|-------------------------------|-------|---------|------------|
| Clam Shell Salad Bowl Acrylic | Clear | 4113 | 220mm |
| | White | 4113-W | 220mm |
| | White | 4115-W | 280mm |



| DESCRIPTION | | ITEM NO | DIMENSIONS |
|----------------------------|--|---------|------------|
| Plate Cover 18/8 | | 7309 | 230mm |
| | | 7310 | 250mm |
| Plate Cover 18/8 Multi-Fit | | 7732 | 230-260mm |
| | | 7734 | 250-280mm |
| Plate Cover Plastic Clear | | 4449 | 230mm |
| | | 4450 | 260mm |

| DESCRIPTION | | ITEM NO | DIMENSIONS |
|-------------------------------|--|---------|------------|
| Napkin Holder Stainless Steel | | 7281 | 130x80mm |



| DESCRIPTION | | ITEM NO | DIMENSIONS |
|-------------------------------------|--|---------|---------------|
| Seafood Platter Stand Chrome Plated | | 7700 | 200x250x190mm |

Servingware - Cake Stands

| DESCRIPTION | ITEM NO | DIAMETER | HEIGHT |
|----------------------------|---------|----------|--------|
| Cake Stand Stainless Steel | 4125 | 300mm | 170mm |
| Cake Stand | 4124 | 300mm | 75mm |



| DESCRIPTION | ITEM NO | DIAMETER | HEIGHT |
|------------------|---------|----------|--------|
| Cake Stand 18/10 | 4127 | 305mm | 146mm |
| | 4128 | 356mm | 145mm |



| DESCRIPTION | ITEM NO | DIMENSIONS | HEIGHT |
|--|---------|------------|--------|
| Cake Cover Acrylic with Chrome Handle | 4140 | 300mm | 185mm |
| Cake Cover Acrylic with Moulded Handle | 4141 | 300mm | 170mm |



| DESCRIPTION | ITEM NO | DIMENSIONS | HEIGHT |
|--|---------|------------|--------|
| Cake Cover Acrylic with 3 Tier Wire rack | 4150 | 300mm | 230mm |
| with 3 Tier Wire Rack | | | |
| Cake Cover | 4145 | 300mm | 230mm |
| 3 Tier Wire Rack | 4156 | 255mm | 150mm |



Servingware - Tableservice



| DESCRIPTION | ITEM NO | DIMENSIONS | DEPTH |
|--|---------|------------|-------|
| Steak Sizzler Cast Iron with Wood Base | 4021 | 290mm | 180mm |
| Steak Sizzler Cast Iron with Wood Base with Hammerstone Finish | 4120 | 240mm | 140mm |



| DESCRIPTION | ITEM NO | DIMENSIONS |
|---|---------|------------|
| Garlic Prawn Pot Cast Iron with Wood Base | 4621 | 110x60mm |



| DESCRIPTION | ITEM NO | SET |
|----------------------------|---------|--------|
| Revolving Condiment Server | 4163 | 3 Bowl |
| Plastic Bowls | 4164 | 4 Bowl |
| | 4165 | 5 Bowl |
| Revolving Condiment Server | 7153 | 3 Bowl |
| Stainless Steel Bowls | 7154 | 4 Bowl |
| | 7155 | 5 Bowl |



| DESCRIPTION | ITEM NO | DIMENSIONS |
|-----------------------|---------|------------|
| Woven Salad Bowl Wood | 9406 | 150mm |
| | 9408 | 200mm |
| | 9410 | 250mm |
| | 9412 | 300mm |
| | 9414 | 350mm |
| | 9416 | 400mm |
| | 9418 | 450mm |



| DESCRIPTION | ITEM NO | DIMENSIONS |
|-----------------------------|---------|------------|
| Round Woven Tray Wood | 9310 | 250mm |
| | 9313 | 330mm |
| Woven Salad Server Wood 2pc | 9411 | 280mm |
| | 9413 | 330mm |

Servingware Accessories

| DESCRIPTION | | ITEM NO | DIMENSIONS |
|----------------------------|-------------|---------|------------|
| Steak Marker (Pack of 500) | Assorted | 45020 | 65mm |
| | Rare | 45022 | 65mm |
| | Medium Rare | 45023 | 65mm |
| | Medium | 45024 | 65mm |
| | Medium/Well | 45025 | 65mm |
| | Well/Done | 45026 | 65mm |



| DESCRIPTION | | ITEM NO | DIMENSIONS |
|---|------------|---------|------------|
| Toothpick Flag (Pack of 500) *Contains UK, USA, Mexico, France & Italy | Assorted * | 45030 | 65mm |
| | Australia | 45031 | 65mm |
| | England | 45032 | 65mm |
| | USA | 45033 | 65mm |
| | Mexico | 45034 | 65mm |
| | France | 45035 | 65mm |
| | Italy | 45036 | 65mm |
| | China | 45037 | 65mm |



| DESCRIPTION | | ITEM NO | DIMENSIONS |
|------------------------|----------------|---------|------------|
| Toothpick Cello Filled | (Pack of 1000) | 45050 | 65mm |
| Club Pick Cello Filled | (Pack of 1000) | 45055 | 100mm |



| DESCRIPTION | | ITEM NO | DIMENSIONS |
|------------------------------|----------------|---------|------------|
| Toothpick Flat | (Pack of 500) | 45070 | 60mm |
| Toothpick Notched | (Pack of 300) | 45075 | 60mm |
| Toothpick Double Ended Round | (Pack of 300) | 45080 | 65mm |
| | (Pack of 1000) | 45090 | 65mm |
| Toothpick Individual Wrap | (Pack of 1000) | 45095 | 65mm |



| DESCRIPTION | ITEM NO | DIMENSIONS |
|---|---------|------------|
| Cocktail Parasols 100/Pack | 45010 | 100mm |
| Cocktail Pick Plastic 5000/Ctn (assorted colours) | 4025 | 65mm |
| Swizzle Sticks 1000/Carton (assorted colours) | 4027 | 185mm |



A

Accessories, chafers 18-21

B

Baby wave chafers 4
 Bar caddy 53
 Bar runner 55
 Bar shakers 52
 Bar spoon 52
 Bar strainer 52
 Beverage servers 26-30
 Bottle cap catcher 53
 Bottle openers 48-51,53
 Bowl 62
 Brackets 54
 Brackets, clamp 54
 Brackets, wall 54
 Bread basket 33-34
 Bread tray 34
 Bucket stand 46
 Buckets 47
 Buffet holder 44
 Buffet servers 36
 Buffet sign 45

C

Caddy 53
 Cake cover 63
 Cake server 36
 Cake stand 63
 Cake tong 37
 Cap catcher 53
 Cast iron sizzler 64
 Catcher, bottle 53
 Catcher, cap 53
 Ceramic inserts 5,20-21
 Cereal dispenser 11
 Chafer inserts 5
 Chafers 3,4,6-8,12-17
 Champagne buckets 47
 Champagne stopper 49-51
 Cheese grater 39
 Cheese shaker 41
 Citrus squeezer 57
 Clam shell bowl 62
 Clamp brackets 54
 Clearing trolley 60
 Cocktail parisol 65
 Cocktail pick 65
 Cocktail shakers 52
 Coffee decanter 27
 Coffee pots 28-30
 Coffee urn 9,15
 Combo measure 55
 Condiment bowl 23
 Condiment dispenser 53-64
 Conical seafood dish 32
 Cork extractor 48-51
 Cork, re-corking 56
 Country flag, pick 65
 Cracker 32,50
 Creamers 28-30
 Cup rack 58

D

Dipper 43
 Display trays 22-24,31
 Dolly 60
 Double jigger 55
 Dredge 42

E

Egg cup 33
 Electric chafer 16
 Electric elements 20
 Expansion stopper 49
 Extenders 58-59

F

Flag, pick 65
 Flatware washrack 59
 Flour, dredge 42
 Food tong 37
 Fuel holder 19

G

Garlic prawn pot 64
 Gastronorm inserts 20
 Gastronorm trays 24
 Gelati spade 43
 Glass basket 56
 Glass, hanger 56
 Glass, washrack 58-59
 Gravy boat 31
 Gravy ladle 36

H

Handy fuel 19
 Hanger 56
 Hawthorn strainer 52
 High tea stand 25

I

Ice bucket 47
 Ice bucket stand 46
 Ice pail 52
 Ice scoop 57
 Icecream spade 43
 Icecream dipper 43
 Icecream scoop 43
 Induction server 3
 Insulated buckets 47
 Insulated jugs 26-27
 Insulated wine cooler 47
 Insulator pail 52

J

Jigger 55
 Jugs 26-29
 Juice dispensers 10

K

Ketchup dispenser 42

L

Ladle 36
 Lobster cracker 32,50
 Lobster pick 32
 Luggage rack 61

M

Measures 54-55
 Menu holder 44

| | |
|------------------------|---------------------|
| Milk dispenser | 11 |
| Milkshake cup | 43 |
| Muddling spoon | 52 |
| N | |
| Napkin Dispenser | 42 |
| Napkin holder | 62 |
| O | |
| Oblong chafer | 3 |
| Oil bottle | 41 |
| Opener, wall | 53 |
| Oval basket | 33-34 |
| Oval platters | 22 |
| Oyster plate | 32 |
| P | |
| Pastry tong | 37 |
| Peg rack | 59 |
| Pepper mills | 38-39 |
| Pie server | 36 |
| Plastic trays | 35 |
| Plate cover | 62 |
| Plate stacking | 61 |
| Plate stacking trolley | 61 |
| Platter stand | 62 |
| Platters | 22 |
| Pourer, spirit | 55 |
| Pourer, sugar | 41 |
| Prawn pot | 64 |
| Punch bowl | 25 |
| R | |
| Rack, luggage | 61 |
| Rack, oil/Vinegar | 41 |
| Rack, salt/pepper | 41 |
| Re-corking device | 56 |
| Rectangular chafers | 3-4,6-7,12-14,16-17 |
| Rectangular trays | 23-24,31,35 |
| Reserve sign | 44-45 |
| Round basket | 33-34 |
| Round chafers | 3-4,6-7,12-13,15 |
| Round induction | 3 |
| Round inserts | 5,21 |
| Round trays | 22,35 |
| S | |
| Salad bowl | 62,64 |
| Salad fork | 36 |
| Salad servers | 36 |
| Salad spoon | 36 |
| Salad tong | 37 |
| Salt & pepper shakers | 40 |
| Salt dredge | 42 |
| Salt mills | 38-39 |
| Sauce bottle | 42 |
| Sauce chafer | 8 |
| Sauce cup | 32 |
| Scissor tong | 37 |
| Scoop | 43 |
| Seafood cocktail dish | 32 |
| Service trolley | 60-61 |
| Serving bowl | 23 |
| Serving tongs | 36 |
| Signs | 44-45 |
| Sizzler | 64 |

| | |
|-------------------------|-------------|
| Snail fork | 32 |
| Snail plate | 32 |
| Snail tong | 32 |
| Solid fuel | 19 |
| Soup induction | 3 |
| Soup ladle | 36 |
| Soup station | 8 |
| Soup tureen | 31 |
| Soup warmer | 16 |
| Spaghetti tong | 37 |
| Speed pourer | 55 |
| Speed rack | 53 |
| Spirit measures | 54-55 |
| Squeeze bottle | 42 |
| Steak marker | 65 |
| Steak sizzler | 64 |
| Stick, swizzle | 65 |
| Stoppers | 49-51 |
| Straw dispenser | 42 |
| Sugar bowls | 28-30 |
| Sugar dispensers | 41 |
| Sugar packet holder | 33 |
| Sundae cup | 31 |
| Swizzle Stick | 65 |
| Syrup dispenser | 41 |
| T | |
| Table number | 44-45 |
| Table number stand | 44 |
| Table stand | 46 |
| Tea pots | 28-30 |
| Tea strainer | 33 |
| Toast wrack | 33 |
| Tongs | 36-37,57 |
| Tomato sauce | 42 |
| Toothpick | 65 |
| Tray stand | 61 |
| Trays | 22-24,31,35 |
| Trolley | 60-61 |
| Trolley, plate stacking | 61 |
| Trolley, service | 60 |
| Trolley, service | 60 |
| Turkish coffee pot | 30 |
| V | |
| Vinegar bottle | 41 |
| W | |
| Waiters friend | 49-51 |
| Wall brackets | 54 |
| Wall opener | 53 |
| Washrack, cover | 59 |
| Washrack, extenders | 58-59 |
| Washrack, flatware | 59 |
| Washracks | 58-59 |
| Water jugs | 26,28-29 |
| Wine bucket stand | 46 |
| Wine buckets | 47 |
| Wing corkscrew | 49-51 |
| Wire basket | 33 |
| Wok induction server | 3 |
| Wood trays | 35 |

Contact Details

Tomkin Australia Pty Ltd

Head Office: 148 McEvoy Street, Alexandria 2015
Sydney NSW Australia
Postal: PO Box 501 Double Bay NSW 2028
Email: sales@tomkin.com.au
Web: www.tomkin.com.au
www.tablekraft.com.au
ABN: 59001 317 862

For your nearest Tomkin distributor please contact the following state offices:

Sydney: 02 9319 2993

Victoria and Tasmania: 03 9415 6788

Queensland: 07 3257 3999 or 07 3252 1277

Western Australia: 08 9225 6848

South Australia and Northern Territory: 08 8297 1122



Tomkin, tablekraft, Chef Inox Professional and the "TK" logo are all trade marks of Tomkin Australia Pty Ltd. Chef Inox, Profile, Gravity, Club, Elite are registered to Tomkin Australia Pty Ltd. Copyright of this catalogue is reserved, 2004. No part of this catalogue may be copied, stored or transmitted without prior written authorisation from Tomkin Australia Pty Ltd. Additionally, no elements of this catalogue may be used by a commercial party not authorised by Tomkin Australia Pty Ltd to do so. Any breaches will result in Tomkin Australia Pty Ltd prosecuting the offending party.

All enquiries should be addressed to Tomkin Australia Pty Ltd. Tomkin Australia Pty Ltd reserves the right to change product specifications without prior notice and will not be held responsible for any errors or omissions.